

Einstein™ Pro XL

Operations and Maintenance Guide



Table of Contents

Identification 5
 Legal Notice 5
 History of Changes..... 5
User Information.....7
 Purpose of the Document..... 7
 Target Group..... 7
 Operator’s Perspective 7
Technical Data 8
 Mechanical Data 8
 Electrical Requirements 8
 Network Requirements 9
 Radio Equipment 9
 Intended Environmental Conditions..... 9
 Storage Conditions for Materials..... 9
Printer Delivery 10
 Unbox Printer..... 10
 Starter Kit 10
Printer Components 12
 Functional Description 12
 Construction of Printer 12
 Front View 12
 Back View..... 13
 Side View 14
 Main Printer Components..... 15
 Hood..... 15
 RFID Material Tag Reader 15
 Build Platform 16
 Material Tray..... 16
 Z-axis..... 17
 Emergency Stopping Devices..... 17
Hardware Setup 18
 Install Hood Counterweight 18
 Connect Printer 18
 Plug & Play 18
 Turn Printer On 19
 Connect Parts Washing Apparatus..... 19
 Connect Post Curing Units 19
 Install Build Platform 20
 Install Material Tray 20
 Add Material 21
 Set Ethernet 22
 Set Wi-Fi 22
 Connect to Another Wi-Fi Network 23

Connect to Printer via VNC Clients.....	24
Supported Clients for Windows	24
Supported Clients for Linux	25
Supported Clients for Android	25
Supported Clients for iOS.....	25
Software Presentation	26
Einstein Pro XL Control Software	26
Settings Menu	26
Network Settings	26
Wi-Fi.....	26
Ethernet	27
Material Info	27
Printer Settings.....	27
Printer Name.....	28
Units.....	29
About Printer	29
Software Update	30
Software Recovery.....	31
Printing Statistics	32
Usage Analytics	33
Move & Calibration.....	33
Move.....	33
Material Tray.....	33
Quick Calibration	35
Cloud.....	35
Heating.	35
Job Settings	36
Support 36	
Manual Debris Removal.....	37
Job List Menu	37
Service Mode	38
Envision One RP®	38
Calibration	39
Home Position Calibration	39
Check Parallelism and Calibration.....	39
Manual Home Position Calibration	41
Mask Generation.....	43
Use Grey Mask.....	46
Quick Calibration	46
Start Print	47
Check Z-axis	47
Create Print Job in Envision One RP.....	47
Load Job File	48
Map a Network Drive in Windows.....	48
Create Shortcut	50
Load Job via FTP	51
Load Job from USB Drive	51

Load Job from Envision One RP	53
Verify Einstein Pro XL Is Ready to Print	53
Start Print	54
Stop Job	56
Abort Job	57
Delete Job	58
Post-Process	59
Post-Cleaning Supplies and Post-Curing Equipment	59
Remove Build Platform from Printer	59
Detach Models from Build Platform	59
Reset Printer After Printing.....	60
Clean Printed Models	61
Post-Cure Printed Models	61
Finish Post-Processing of Printed Model	61
Service and Maintenance	62
Customer Service	62
Download Log Report	63
Remote Assist	63
Request Support	64
Operational Maintenance	65
Clean Build Platform.....	66
Clean Material Tray	67
Clean Printer Casing	68
Clean Projector Lens	68
Clean Hard Drive Space.....	68
Clean PWA 2000 / Washing Containers	69
Clean Dust	69
Power Cycle	70
Maintain Materials	70

Identification

Legal Notice

This document contains information that is confidential and proprietary to Desktop Metal, Inc. and/or its affiliates, including without limitation EnvisionTEC US LLC, Adaptive3D LLC and ExOne Operating, LLC (each a “DM Company,” and together the “DM Companies”). This information is provided only to authorized representatives or customers of the DM Companies, and solely for the purpose of facilitating the use of DM Companies’ products and services. This document and its contents shall not be used or distributed for any other purposes or communicated, disclosed or copied except as agreed by a DM Company in writing.

The information contained herein is provided for reference only and subject to change without notice. This document provides general information about the products described herein and is not a substitute for the Instructions for Use and Safety Data Sheets for said products. The DM Companies shall not be liable for omissions or for technical or editorial errors contained herein or for any damages whatsoever arising in connection with the furnishing or use of this document. This information is not intended to be used to determine the suitability or reliability of the user’s specific applications or environments; these determinations are the sole responsibility of the user, and the DM Companies disclaim all liability associated therewith. Without limiting the foregoing, the user is solely responsible for the use and operation of the products and services, including the disposal of waste products in connection therewith.

This document does not supplement, replace or otherwise modify the terms and conditions that govern the purchase and sale or use of DM Companies’ products or services. Furthermore, nothing herein shall constitute a warranty; the only warranties for DM Companies’ products and services are those set forth in the express warranty statement in the terms and conditions of sale for said products and services.

Desktop Metal, the DM Logo, Bound Metal Deposition, BMD, Live Sinter, Studio System, Shop System, Fabricate, Fiber, Production System, Desktop Health, Desktop University, Flexcera, Einstein and ETEC are trademarks of Desktop Metal, Inc. EnvisionTEC, Envision One, cDLM, Vida, Perfactory, D4K, Hyperprint and Xtreme 8K are trademarks of EnvisionTEC GmbH and its affiliates. ExOne, the ExOne Logo, Innovent, Innovent+, InnoventX, X25Pro, X160Pro, X1, S-Max, S-Print, CleanFuse, NanoFuse, and HydroFuse are trademarks of ExOne Operating, LLC or its affiliates. ToughRubber is a trademark of Adaptive3D LLC and its affiliates. All other trademarks used herein are the property of their respective owners.

© 2023 Desktop Metal, Inc. All rights reserved.

Einstein Pro XL Operations and Maintenance Guide: PRX-UG-00039-Rev03-EN, May 2023

History of Changes

Date	Changes	Version
Feb-2023	Document creation	1.0
Mar-2023	<ul style="list-style-type: none"> Updated Unbox Printer section 	2.0

Date	Changes	Version
	<ul style="list-style-type: none"> • Added Install Hood Counterweight section • Updated Material Tray section • Updated Install Material Tray section 	
May-2023	<ul style="list-style-type: none"> • Added Radio Equipment section • Updated Connect Post Curing Units section • Updated Post-Cure Printed Models section 	3.0

User Information

Purpose of the Document

This instruction manual:

- describes the working principle, operation, and maintenance of the printer, and
- provides important information on safe and efficient handling of the printer.



Note: The operation of the Envision One RP Software is described in the [Envision One RP Software Manual](#).

This document is an important part of the system and includes important notes, tolerances for calibration tasks if applicable, and must be paid close attention to when starting up the printer and during its operation. Keep this guide close to the printer so the operator can always access it.

Target Group

This instruction manual is intended for:

- the customer (company operating the printer) whose responsible employees have been trained by the manufacturer or the distributor,
- trained operators for operation and
- persons with specialist technical training (mechanics/electrical engineering) for troubleshooting/fault elimination and maintenance.

Operator's Perspective

All the directions and locations in this instruction manual are explained from the working position of the operator.

Technical Data

Mechanical Data

	Einstein Pro XL
Footprint	90 x 60 x 152 cm (35.4 x 23.6 x 59.8 in)
Weight	90 kg (198.4 lb)
Build Envelope	249.125 x 140.135 x 165.1 mm (9.8 x 5.5 x 6.5 in)
XPR Resolution	3840 x 2160 px
XPR Pixel Size	65 µm
Warranty	1 year back to factory included

Electrical Requirements

We strongly recommend you use an uninterruptible power supply to protect your printer. All electrical requirements must be met to ensure the most stable setup:

1. Do not plug any additional equipment into the power circuit.
2. The Einstein Pro XL requires 100-250V AC, 6.3A, 50Hz/60Hz
3. The Einstein Pro XL does not require a dedicated server. It can be connected wirelessly, hard-wired into the network, or directly connected to a computer.

 WARNING	<p>Risk of electric shock: Connect printer to grounded outlet ground wire before using! Only use the grounding adapters of the plug & socket type targeted for the country of intended use of the printer!</p>
---	--

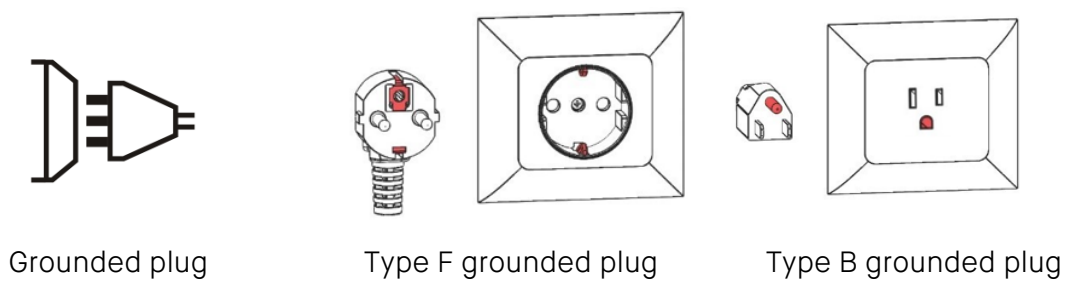

Figure 1: Grounded plugs

Network Requirements

- **139, 445 ports:** are used to access the shared network folder (job, logs, update) on the printer. Also, they are used to upload jobs to the printer via network.
- **5900 port:** VNC server for printer remote control (see section [Connect to the Printer via VNC Clients](#))
- **2504 port:** is used for connection between the Einstein Pro XL Control Software and Envision One RP.
- **22 (ssh) and 443 (https):** are used for getting the software update.

Radio Equipment

Radio equipment contained in this product operates at the following frequencies:

- Wi-Fi Frequency range: 2.4 GHz and 5 GHz band
- RFID Card Reader frequency: 13.56MHz

Intended Environmental Conditions

Storage Conditions for Materials

Materials should be stored under the following conditions:

- at room temperature
- dry
- in closed bottles
- lightproof

If materials are filled in the material tray, the printer hood should always be closed. If you don't need the material tray for a longer time, pack the material tray and store it under the same conditions as mentioned above.



Note: More specific storage conditions for materials can be found in the appropriate Material Best Practice Guide or Instruction of Use provided by manufacturer or distributor.

Printer Delivery

Unbox Printer

Your Einstein Pro XL printer arrives in a wooden crate with a series of accessories boxes. The crate and boxes are on top of a pallet. Use a forklift or pallet jacket to take them to the site. You can also remove the crate and accessories boxes from the pallet and use a dolly to move them.

- **Crate:** Einstein Pro XL
- **External components box:** Starter kit, additional PSA
- **Optional Boxes:** Parts curing apparatus, parts washing apparatus, and battery backup if purchased.

The following tools are required to complete the unboxing process:

- Box cutter/scissors
- Flathead screwdriver
- Adjustable wrench
- Hi-Lo/dolly
- One person to assist

Before opening the box, make sure you see no visible damage or broken sensors. If these are present, please inform [Customer Support](#) immediately.

If everything is in good condition:

1. Carefully cut the plastic wrap.



Note: The plastic wrap does not need to be saved and can be thrown away.

2. Remove the two boxes from the pallet.
3. Place the External Components box on a sturdy work surface.
4. Check the wheels are firmly connected to the base of the printer. If the wheels are loose, use a wrench to tighten them.
5. With a helper, lift the printer from the crate and place the printer on a stable surface.

Starter Kit

The Starter Kit includes useful tools for operating and cleaning the printer and the built parts.

- Network cable, 5mm
- Crossover network cable, 5mm, colored plug
- Feeler gauge, 0.15mm
- Allen keys, 2mm, 2.5mm
- Paint scraper, 50mm
- Material mixing cards
- Grey filter foil
- USB drive
- UV safety glasses

Einstein Pro XL Operations and Maintenance Guide

Allen keys, 2mm, 2.5 mm

Required for printer calibration and to assist with technical support cases. It is not required for day-to-day operation.

Crossover network cable, 5 mm, colored plug

This cable connects the printer to the operating computer, as needed. The cable inserts into the I/O panel behind the printer. The other end plugs into the operating computer.

Feeler gauge, 0.15 mm

Required for printer calibration and to assist with technical support cases. It is not required for day-to-day operation.

Grey filter foil

Required for light calibration and to assist with technical support cases. It is not required for day-to-day operation.

Material mixing cards

Required to gently mix material in the material tray before each print.

Network cable, 5 mm

This cable connects the printer to the local network. The cable inserts into the I/O panel behind the printer. The other end plugs into the network. The printer can be operated by other Windows computers on the network if the CAT 6 is plugged into a modem or into a network outlet.

Paint scraper

Use the scraper to remove printed models from the build platform. Use the paint scraper for detaching larger printed models. You can also use the scraper to remove material residues from the build platform.

USB drive

The USB is a back-up for transferring print information from the operating computer to the printer. Between 8 and 32 GB size is recommended.

UV safety glasses

Required for light calibration and to assist with technical support cases. They are not required for day-to-day operation.

Printer Components

Functional Description

During the build process, the model is built layer by layer. A mechanical system moves the build platform up so that the cured material sticks to the build platform or to the previous layer.

Before starting the build process, certain calibrations must be performed at the factory. The material is then directly poured into the material tray. The job is transferred to the printer through Envision One RP® software or via a USB drive. The build process begins. After the build process has finished, the models are removed from the build platform using a scraper and treated according to the corresponding Material Best Practice guide.

Construction of Printer

The figures below give an overview of the most important printer components and show their position on the printer.

Front View

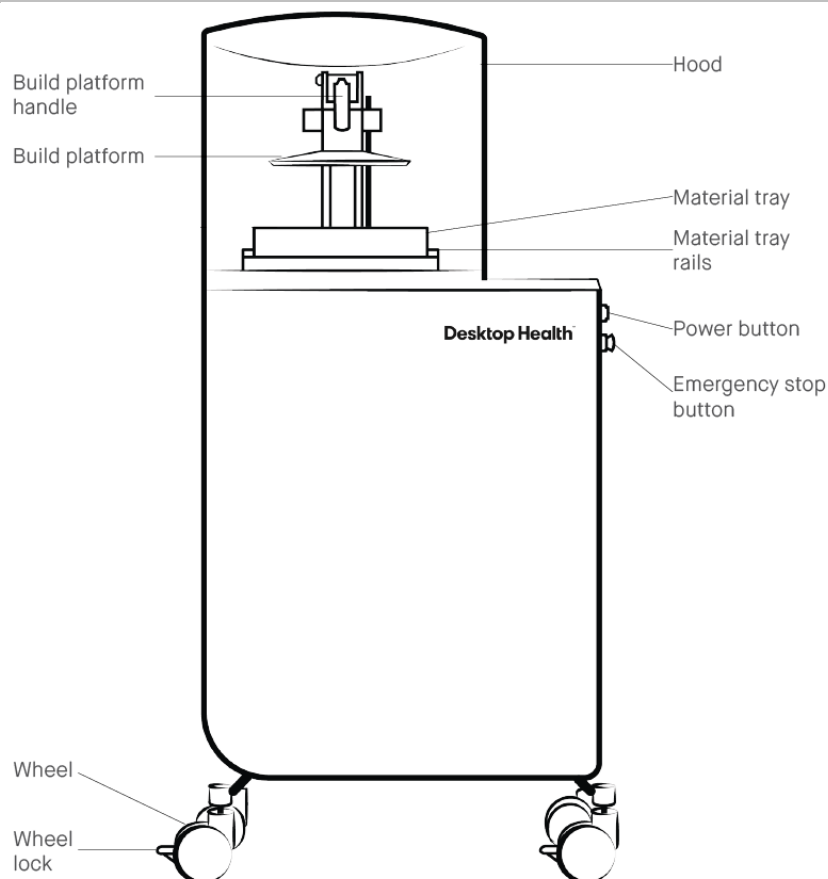

Figure 2: Front view of the printer

Back View

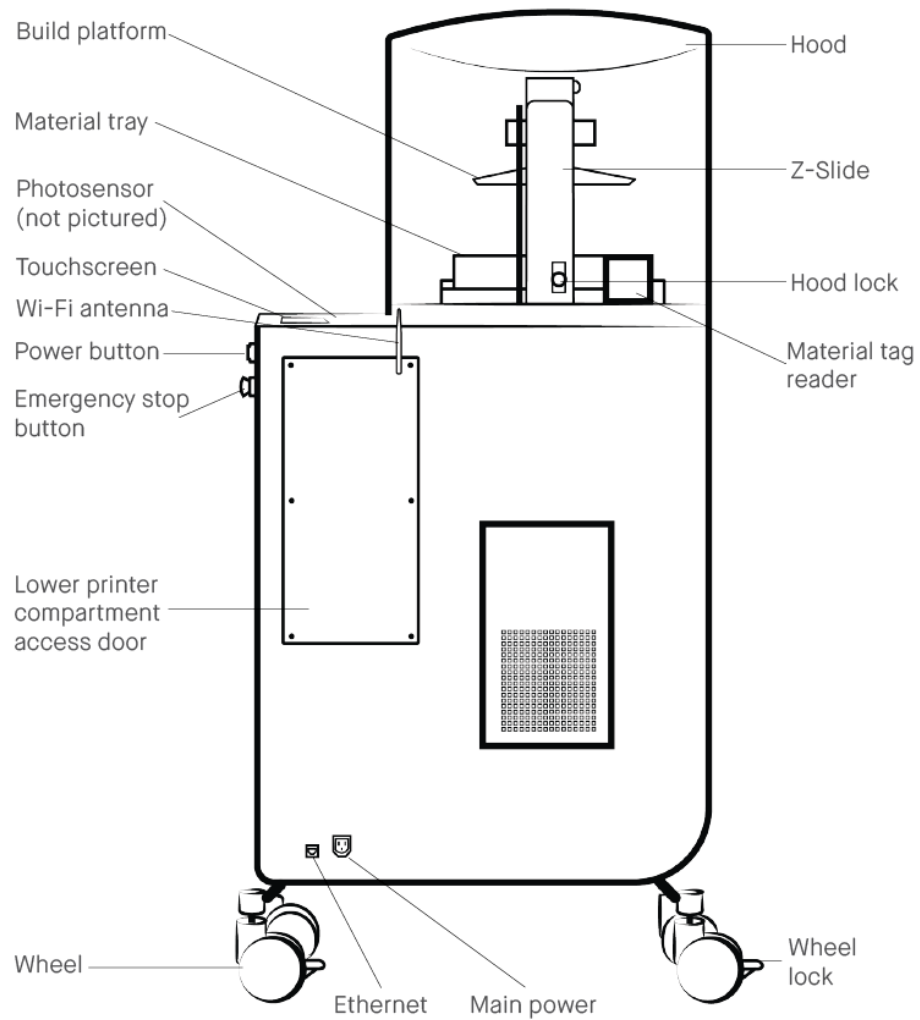

Figure 3: Back view of the printer

Side View

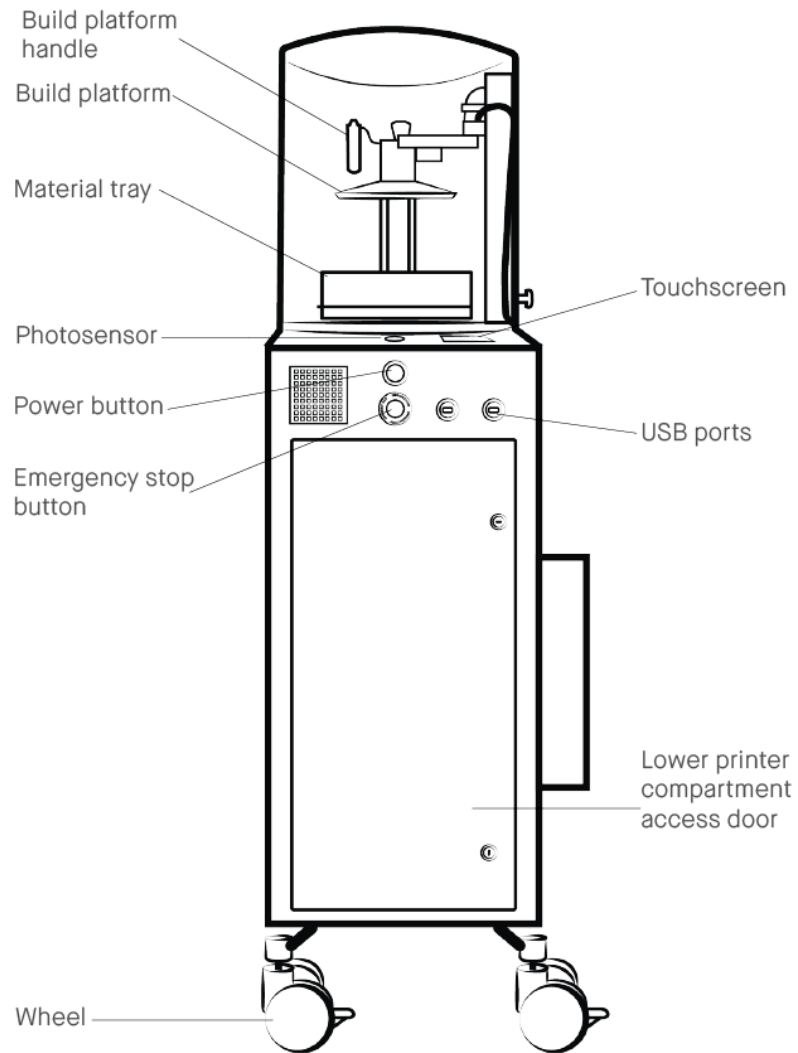

Figure 4: Side view of the printer

Main Printer Components

Hood



CAUTION

Risk of injury: The hood must always be closed, except when removing models from the printer. After the models are removed, close the hood on the printer.

The orange hood protects the printer and the operator. It protects:

- the operator against the movements of the build platform.
- the photopolymer in the material tray from ambient light.
- the printer components from dust and debris.

To open the hood, pull the hood lock on the rear side and then lift hood upwards. The hood has a counterbalance cable that facilitates the upward movement of the hood and keeps it in position when open.

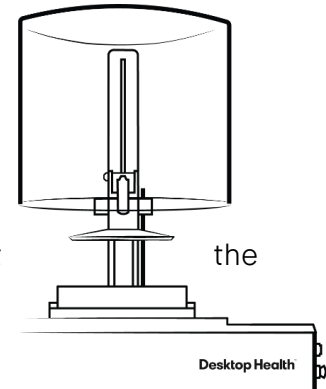

Figure 5: Hood, open

RFID Material Tag Reader

NOTICE

Place the material tag into the reader properly. Failure to do so can result in damage to the RFID material tag and reader.

The software utilizes the very latest RFID technology (Radio Frequency Identification) which tracks the material level in the material bottle.

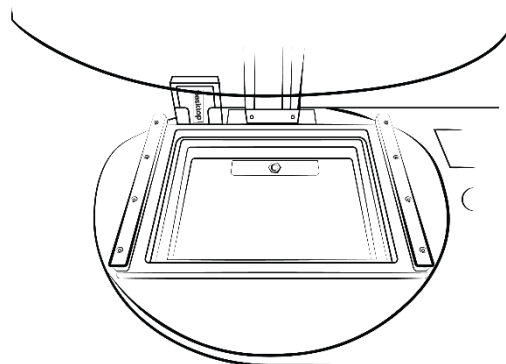

Figure 6: RFID tag reader behind the rear left side of the material tray

Einstein Pro XL Operations and Maintenance Guide

The tag reader prevents usage of a material that does not match the buildstyle or material tag. Place the material tag (shipped with every material bottle) on the tag reader, where it is read and processed by the printer to ensure accuracy.

Build Platform

The build platform is an assembly comprised of:

- A large, flat platform
- A handle
- A connection cavity

The flat area of the build platform is where cured material will adhere during the printing process. The build platform is nickel-plated and is used for medical and technical applications.

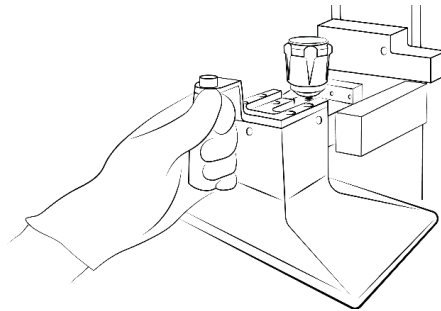

Figure 7: Build platform

Material Tray



Note: Use a different material tray for each kind of material to avoid contamination. If not possible, clean the material tray carefully and thoroughly.

The material tray consists of two plastic frames with a special membrane called Pre-Stretched Assembly (PSA) between them, which fits snugly over a piece of glass when installed on the printer.

As the build platform moves up taking the exposed part away from the PSA, it pulls the membrane up finally releasing it and allowing the parts to separate. The build platform then moves back down and the next image in the sequence is projected; the cycle repeats itself.

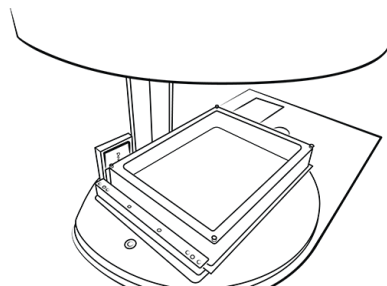

Figure 8: Material tray

Z-axis

The build platform moves up and down along the Z-axis.

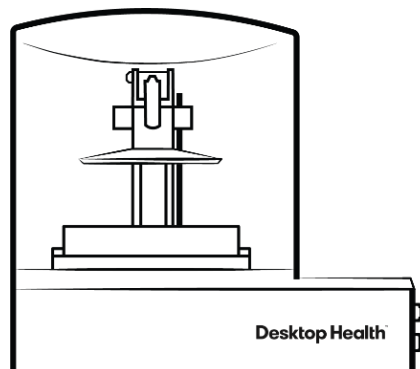

Figure 9: Z-axis

Emergency Stopping Devices

The printer is equipped with an emergency stopping device: a red emergency stop button.

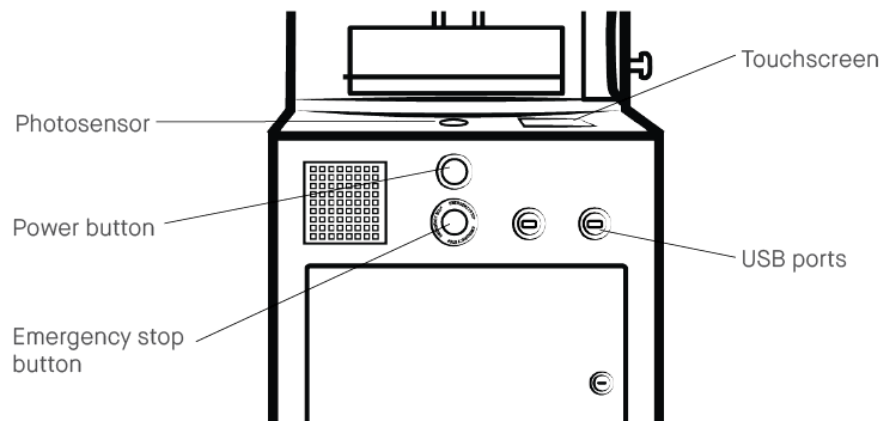

Figure 10: Emergency stopping device

To stop the printer in an emergency, push the emergency stop button.

After eliminating the risk, follow the next steps to restart the printer:

1. Turn the emergency stop button (red) clockwise.
2. Push the power button (green).

NOTICE

All emergency stopping devices and protection doors must be checked one by one and separately. In case of defective safety equipment, shut the printer down immediately and secure it against being turned on again.

Hardware Setup

Install Hood Counterweight



Note: The counterweight of the hood is protected by the transportation lock.

1. With your left hand, pull the hood lock on the rear side of the printer and then lift the hood upwards to open it, see [Install Hood Counterweight](#).



Note: Keep the hood lifted. Do not drop it, until the counterweight is installed.

2. Find the counterweight cable. Carefully pull it up with your right hand and fit it on the reverse roller.
3. Slowly close the hood and make sure the cable is under stress.

Connect Printer

Plug & Play

Connect the following as shown in the diagram below.

- The white antenna: Wi-Fi
- The blue cable: CAT 6 Ethernet cable
- Large black plug: Power

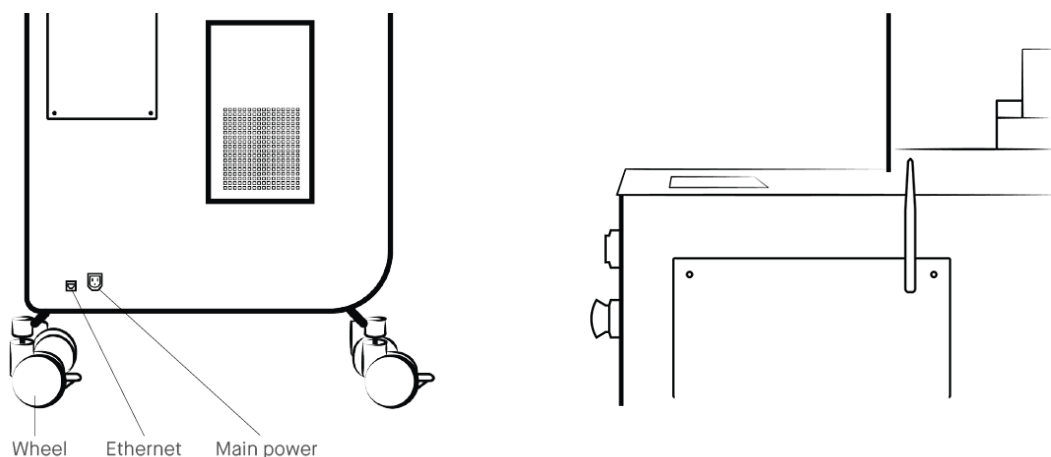



Figure 11: I/O panel and connected Wi-Fi antenna



Note: There are two USB ports on the side of the printer. A USB drive with printer compliance and safety instructions is included in the original shipping box. Desktop Health recommends saving a backup copy of the data on your USB drive in a separate place, such as cloud-based storage, external hard drive, a backup computer, etc.

Turn Printer On

 CAUTION	Risk of injury from crushing caused by moving printer parts: The printer may only be operated by instructed and specially trained personnel and if the protecting devices are working properly.
---	--

To turn the printer on, quickly select and release the power button.

→ The button illuminates and the screen switches on.

→ After a booting sequence, controller software is opened automatically.

NOTICE	Do not touch or open anything on the screen before the Control Software has finished booting. This can cause damage to the files on the printer.
---------------	--

When an update is available for the printer, the following message appears:

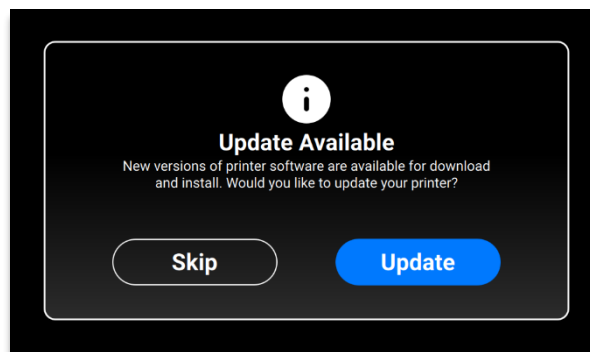

- To update the printer, select **Update**.
- To discard the update message, select **Cancel**.

Connect Parts Washing Apparatus

The PWA 2000 Parts Washing Apparatus is the recommended washing unit for the models printed with the Einstein Pro XL. To set up the PWA 2000 Parts Washing Unit, see the [Desktop Health Knowledge Base](#).

Connect Post Curing Units

The Otoflash is the recommended curing unit for all materials printed with the Einstein Pro XL. To set up the Otoflash post curing unit, see the [Desktop Health Knowledge Base](#).

The PCA 2000 Post Curing Unit is also available for non-medical materials printed with Einstein Pro XL. To set up PCA 2000, see the [Desktop Health Knowledge Base](#).

Install Build Platform

1. Open the printer's hood.
2. Turn the build platform knob on the top of the printer a couple times to loosen it.
3. Slide the build platform into the build platform housing at the top of the Z-axis tower.
4. Tighten the build platform knob down to secure the build platform in place.

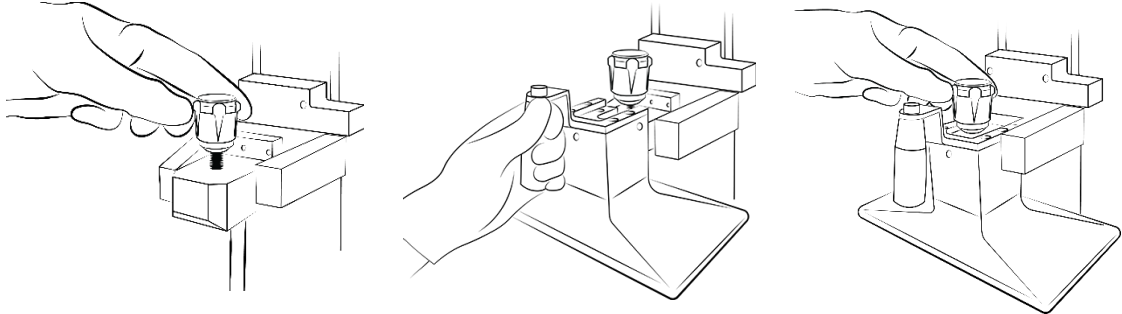

Figure 12: Build platform installation



Note: Securely tighten the build platform before printing. Failure to do so will cause the build platform to be uneven and can cause build failures.

Install Material Tray

The material tray must be installed the same way every time.

1. Locate the front and back of the material tray.

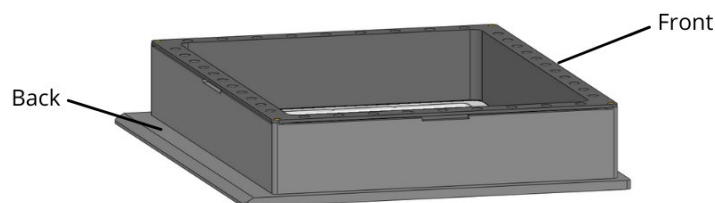

Figure 13: Front and back sides of the material tray marked

2. Position the material tray so that the back of the tray is facing away from you, towards the printer.
3. Slide the material tray under the material tray rails on the right and left sides as far in as it will go.



Note: Make sure the material tray is positioned properly. Incorrect positioning can lead to print failures.

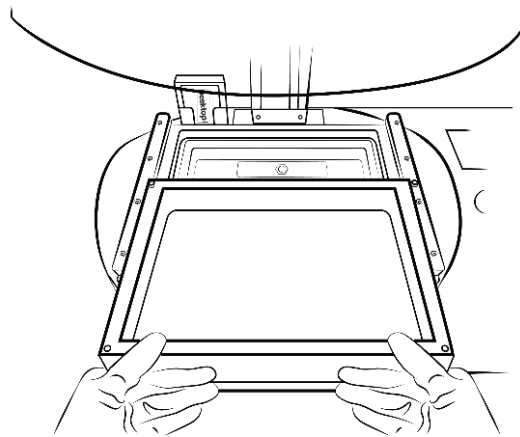

Figure 14: Material tray installation

4. Make sure the material tray is secured.

Add Material

See [Material Best Practices Guide](#).

Be sure to properly prepare your specific material before each use. Always observe the relevant [Material Safety Data Sheets](#) supplied with the material bottle.



CAUTION

Risk of injury: Use the appropriate personal protective equipment.

NOTICE

Always remove the build platform before taking the material tray out of the printer! Failure to do so can result in material dripping down into the safety glass causing failed builds and ruined equipment.

NOTICE

Use a different material tray for each kind of material to avoid contamination. If not possible, clean the material tray carefully and thoroughly.



Note: Ensure the extraction is sufficient. Desktop Health recommends an air change of 25 m³/h per m² effective surface of the laboratory per EN 16798-3 or 3.2 m³/h per m² per US ANSI ASRAE 62. Check local requirements.

1. Open the printer's hood.
2. A material tag is attached to the material bottle. Remove the material tag and place the material tag on the material tag reader.
3. Shake the material bottle well. Open the material bottle and pour the material slowly into the material tray to the material fill line.

4. Mix the material thoroughly with a supplied material mixing card. Close the hood to protect the material from ambient light.

Set Ethernet



Note: The Einstein Pro XL is compatible with both ethernet and Wi-Fi connections.

1. Plug the Ethernet cable into the network connector located on the back of the printer.
2. Connect the Ethernet cable to your network.
3. On the printer screen, select **Settings > Network Settings > Ethernet**.

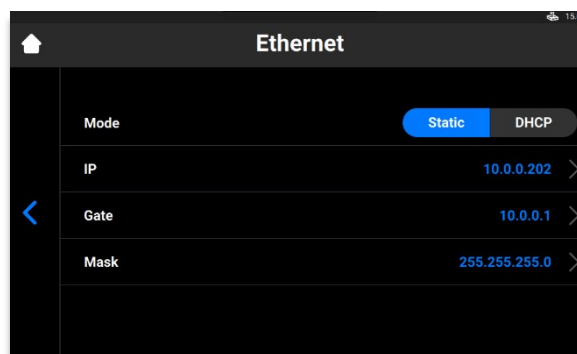

There are two types of Connection: static and dynamic. **Dynamic connection** or **DHCP** – assigns the printer a dynamic IP address. All the fields are greyed out.

4. To set the **Static** connection, complete the fields manually using the settings for your network.

Set Wi-Fi

1. Select **Settings > Network Settings > Wi-Fi** on the touchscreen.
2. Select the required Wi-Fi name.



3. Select **Join**.

4. In the Password field, type a password for the selected Wi-Fi.



5. Select OK.

Connect to Another Wi-Fi Network

1. Enter the Wi-Fi tab by selecting **Settings > Wi-Fi** on the touchscreen.
2. Select the network you want to disconnect from.

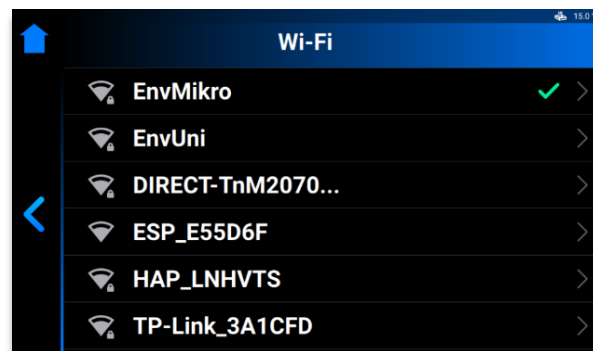

3. Select Disconnect.

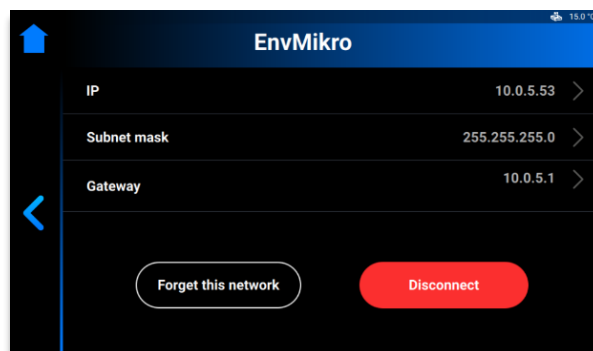

4. Proceed with the steps outlined in the [Set Wi-Fi](#) section.



Note: Select **Forget this network** to disable automatic connection to the current Wi-Fi network. It is possible to reconnect to this network again in the future. The system will ask for a password for protected Wi-Fi networks.

Connect to Printer via VNC Clients

VNC Clients allows the printer operator to view printer status from a computer, remotely control the printer within reason, and provide remote access to the printer during a Technical Support Case.

NOTICE	<p>Improper use of the remote printer control over local network using VNC software may lead to damage.</p> <p>Use the remote printer control with great attention.</p> <p>Do not use the remote printer control without an operator next to printer.</p> <p>The printer owner is responsible for any unsafe operation of the printer using the remote printer control.</p>
--------	---

Supported Clients for Windows

VNC Viewer

Step-by-step:

1. Download the VNC Viewer and open it.
2. Type the IP address into the VNC Server box.

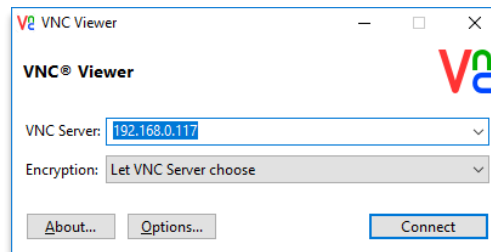

3. Select Connect.

UltraVNC Viewer

Step-by-step:

1. Download UltraVNC Viewer and open the program.
2. Type the IP address into the VNC Server box.

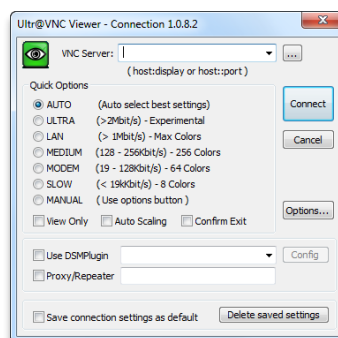

3. Select Connect.

Supported Clients for Linux

VNC-Viewer

Step-by-step:

1. Download VNC Viewer and open the program.
2. Type the IP address into the VNC Server box.

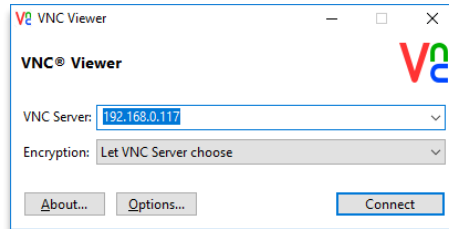

3. Select Connect.

Supported Clients for Android

bVNC Free

Step-by-step:

1. Type the connection name and the IP address into the fields marked below.

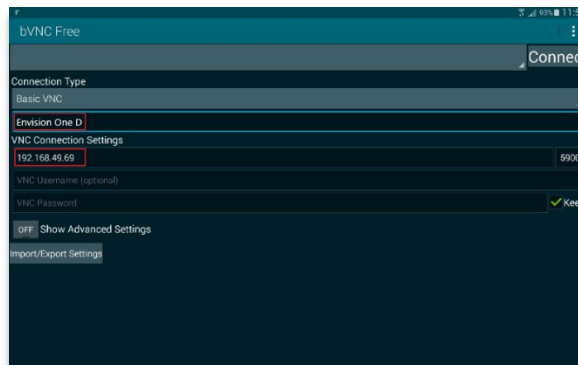

2. Select Connect.

Supported Clients for iOS

VNC Viewer

Type the IP address and the connection name into the **Address** and **Name** boxes.

Software Presentation

Einstein Pro XL Control Software

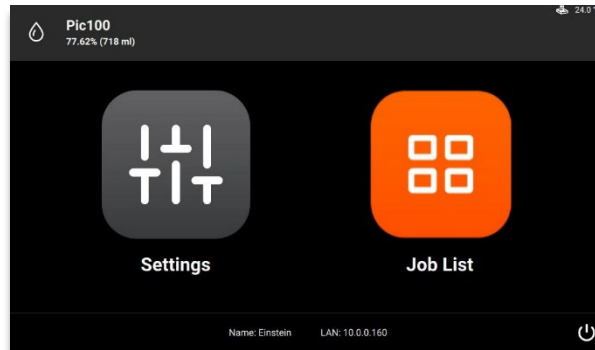



In the Control Software, there are two main menus: **Settings Menu** and **Job List Menu**.

Settings Menu

The **Settings Menu**:

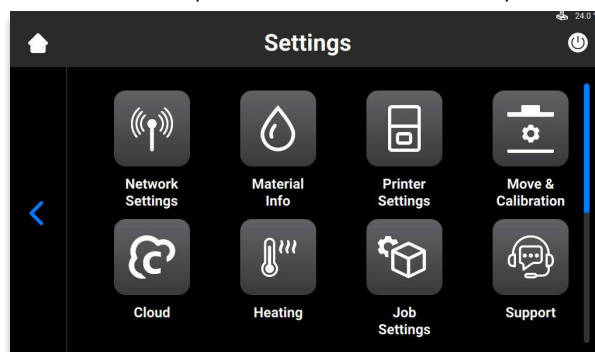
- allows you to change settings of the printer build parameter or the printer itself.
- gives further information about the printer or the LAN connection.
- allows the user to switch the printer off electronically.



To exit the Settings Menu, select the  icon on the left of the screen.

To enter the main screen, select the **Home** icon on top-left corner of the screen.

Network Settings

Wi-Fi

The Wi-Fi tab lets you set the Wi-Fi connection on the printer.

Select **Settings > Network Settings > Wi-Fi** to open the tab, see section [Set Wi-Fi](#).

Ethernet

This tab lets you set the network on the printer.

Select **Settings > Network Settings > Ethernet** to open the tab, see section [Set Ethernet](#).

Material Info

The **Material Info** tab provides information about:

- the type of material used on the printer.
- the amount of the material left on the material tag.

Select **Settings > Information > Material Info** to open the tab.



Select the  icon to update the data from the RFID tag reader. To change the material tag, proceed as follows:

1. Remove the material tag from the tag reader.
2. Put the new material tag on the tag reader.
3. Select the  icon.

→ The material information is updated based on your new material tag.

Printer Settings

The **Printer Settings** tab:

- provides information about the printer.
- allows you to change the printer's name, select units of measurement, and update the software.

To open the tab, select **Settings > Printer Settings**.

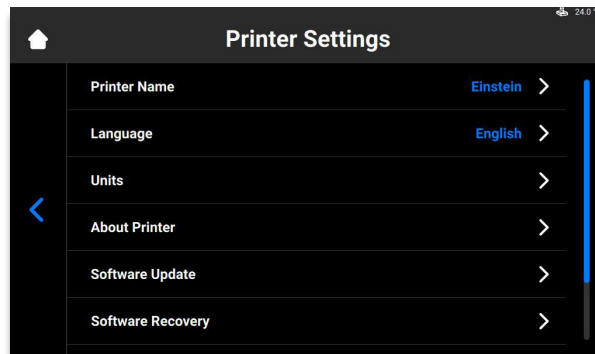

Printer Name

This option lets you change the name of a printer.

1. Select **Settings > Printer Settings > Printer Name**.

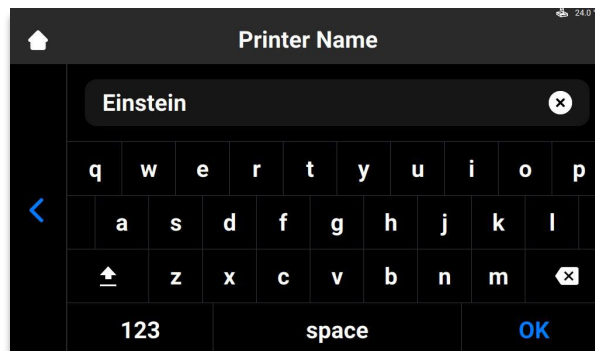

2. Enter the required name of the printer into the corresponding field using the keyboard on the screen.



Note: Printer name may contain:

- Letters from A to Z.
- Digits from 0 to 9.
- A hyphen (-).

It may not:

- Include spaces.
- Include special characters.
- Begin with a number or a hyphen.

3. Select **OK**.
→ The printer's name is changed.

Units

The **Units** tab lets you select the units of measurement for the motion parameters.

1. Select **Settings > Printer Settings > Units**.

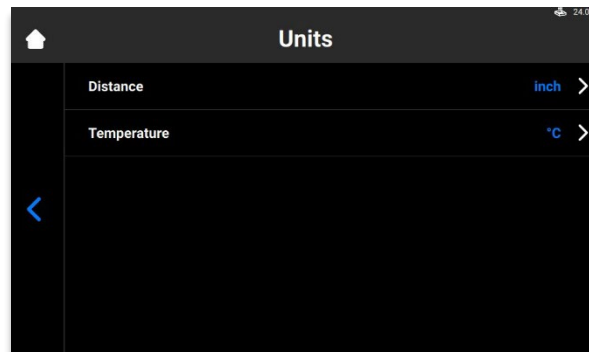

1. Select **Settings > Printer Settings > Units > Distance**.
2. Select **Inches** or **Millimeters** by selecting the corresponding field.
3. Select **Settings > Printer Settings > Units > Temperature**.
4. Select **Fahrenheit** or **Celsius** by selecting the corresponding field.
→ The units of measurement are changed.

About Printer

To view information about the printer, select **Settings > Printer Settings > About Printer**.

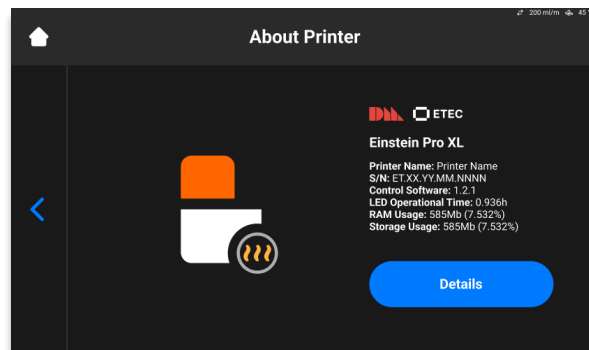

- **Printer Name:** name of the printer.
- **S/N:** printer serial number.
- **Control Software:** version of control software set on the printer.
- **LED Operational Time:** time of LED operation.
- **RAM Usage:** volume of the occupied memory (as percentage of the total volume).
- **Storage Usage:** volume of the occupied storage (as percentage of the total storage).

Einstein Pro XL Operations and Maintenance Guide

For more detailed information on the printer, select **Details**.

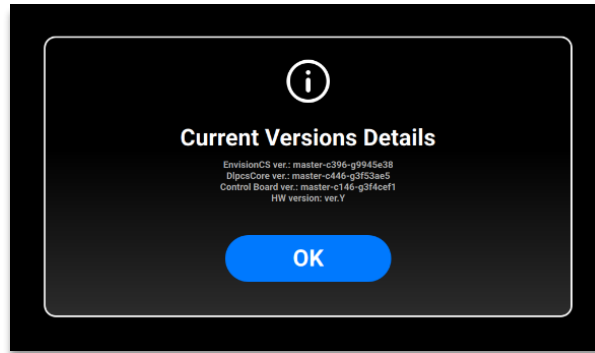

- **EnvisionCS ver.:** version of control software set on the printer.
- **DlpcsCore ver.:** version of the DLPCS Core.
- **Control Board ver.:** version of control board.
- **HW version:** version of firmware set on the printer.

To return to **About Printer** tab, select **OK**.

Software Update

Select **Settings > Printer Settings > Software Update** on the printer screen to check the software version installed on the printer.

If the latest version of software is installed on the printer, the **ChangeLog** button displays. Select it to view detailed information about the current version.

If a new version of software is available, the **Update** button displays.

NOTICE	Do not turn the printer off during update!
---------------	--

Step-by-step:

1. Select **Update**.

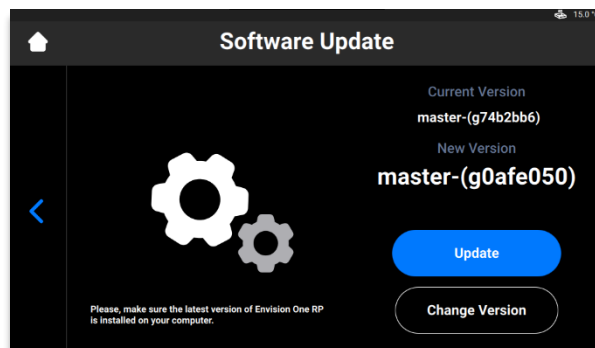

Einstein Pro XL Operations and Maintenance Guide

2. Select Start.

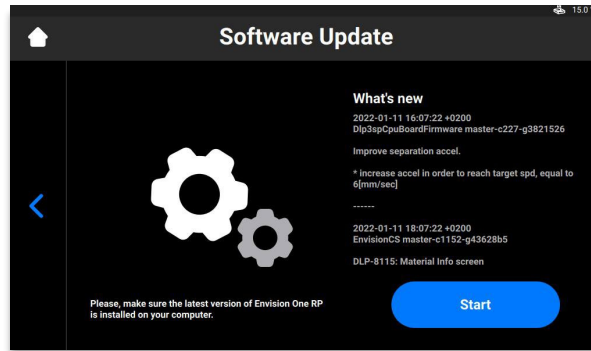

- The update process starts.
- The following screen appears.

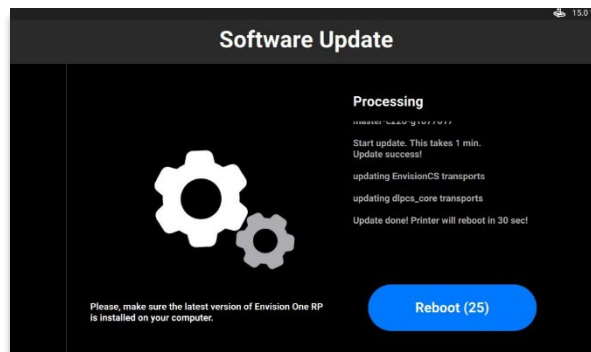

3. To reboot the printer manually, select Reboot. If not, it will start rebooting automatically in 30 seconds.

Software Recovery

The Software Recovery tab lets you recover the previous version of software.

1. Select Settings > Printer Settings > Software Recovery to open the tab.
 - The following screen appears.

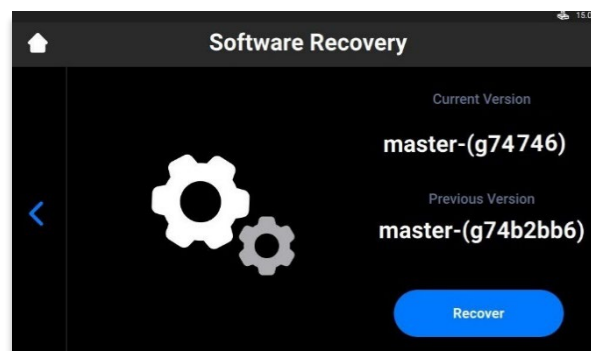

2. Select Recover to get back to the previous version of Control Software.

Einstein Pro XL Operations and Maintenance Guide

→ The following message appears.

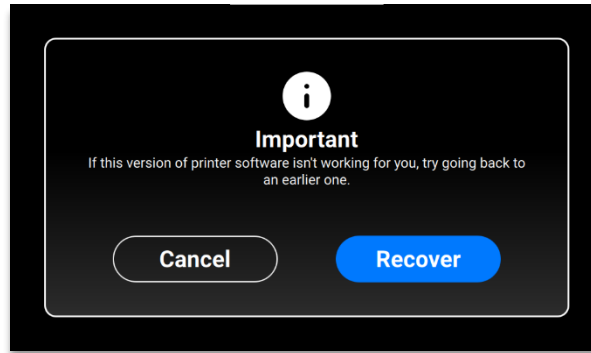

3. Select **Recover** to confirm the Software recovery.
 - The process of software recovery starts.
 - The following screen appears.

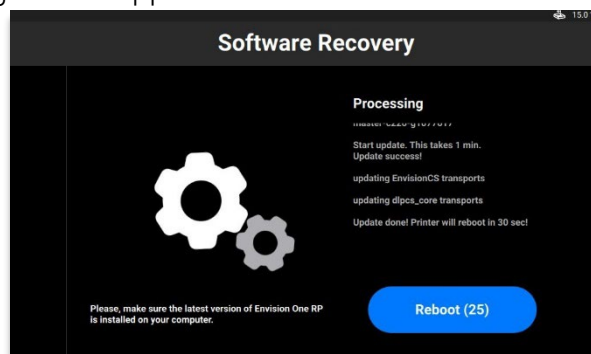

4. To apply changes, reboot the printer. It automatically reboots in 30 seconds. To reboot the printer manually, select **Reboot**.

Printing Statistics

This tab provides the printer usage data for the last 7 days, last 30 days or all operations data.

Select **Settings > Printer Settings > Printing Statistics**.

→ The following screen appears.



The following information is shown:

- **Job evaluation data:** quality of finished jobs (successful, partially successful and failed).
- **Materials usage:** name and volume of each material in use.
- **Job quantity:** quantity of completed, aborted, and failed jobs.

- **Average print duration:** average duration of the job in hours.
- **Damaged material trays:** number of material trays marked as damaged.

Usage Analytics

Collecting and sending statistics automatically will help Desktop Health improve our products.

1. Select **Settings > Printer Settings > Usage Analytics**.
2. Check the **Usage Analytics** checkbox to consent to collection and usage of customer data.

Move & Calibration

The **Move & Calibration** tab is used for moving the build platform and calibration the Home position.

Move

This tab lets you move the build platform along the Z-axis.

1. Select **Settings > Move & Calibration > Move** to open the tab.



2. Select the up and down arrows to move the platform up and down correspondingly.
 - **Zero position:** the highest position of the build platform along the Z-axis.
 - **Home position:** start position of the build platform for printing.
 - **Safe position:** safe position of the build platform between Zero position and Home position.

Material Tray

This tab shows the list of material trays and provides a possibility to add a new one.

NOTICE

Make sure your material tray does not contain material in it. Material residue in the material tray during the calibration gives a false reading to the sensors.

Add New Material Tray

1. Select Settings > Move & Calibration > Material Tray > Add New Material Tray.

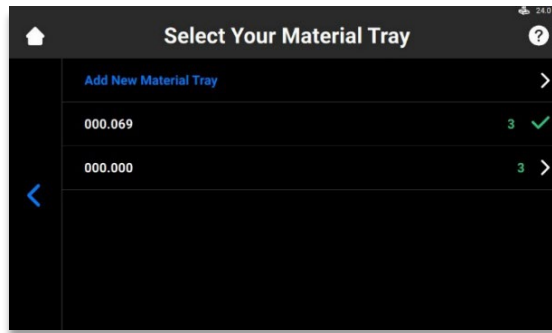

2. Name your material tray and enter the name to the field on the screen that appears. The name should contain 7 digits from 0 to 9.



3. Select OK.
→ The material tray is added to the list.

Delete Material Tray from List

1. Select Settings > Move & Calibration > Material Tray.

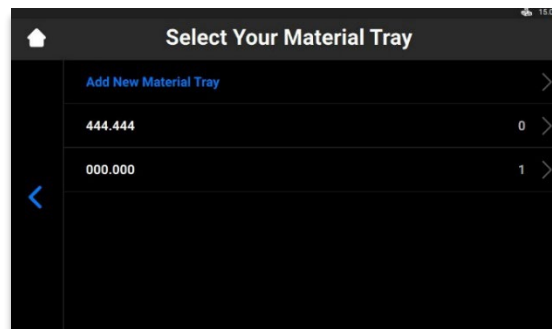

2. Press on the material tray name on the list.

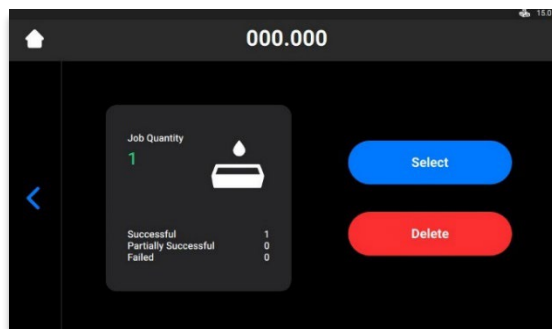

3. Select **Delete**.
→ The material tray is deleted.

Quick Calibration

Select **Settings > Move & Calibration > Quick Calibration** to open the tab.

For detailed information, see section [Quick Calibration](#) of this User Manual.

Cloud

The Cloud service is not released. Once the ET Cloud is released, you will be able to register your printer in the system.

1. Select **Settings > Cloud** to open the tab.

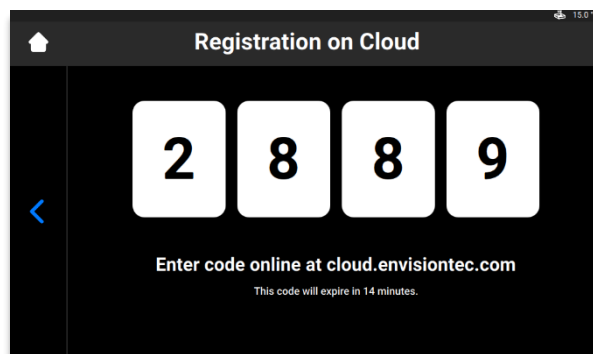

2. Type the obtained code to the registration window at cloud.envisiontec.com.

Heating

This tab lets you preheat the material tray for the best print results.

1. Select **Settings > Heating** to open the tab.

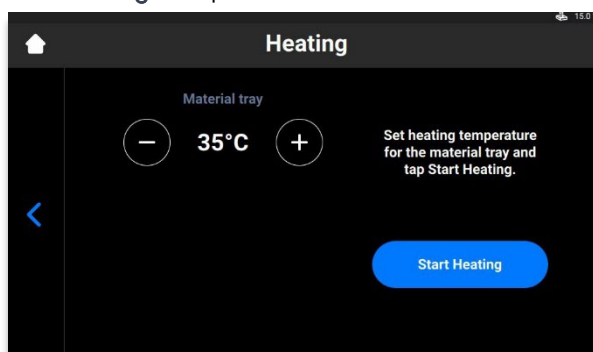

2. Set the required heating temperature for the material tray using the **plus** and **minus** buttons.
3. Select **Start Heating**.
→ The material tray starts heating.

Job Settings

This tab lets you check or change the printer settings.

Select **Settings > Job Settings** to open the tab.

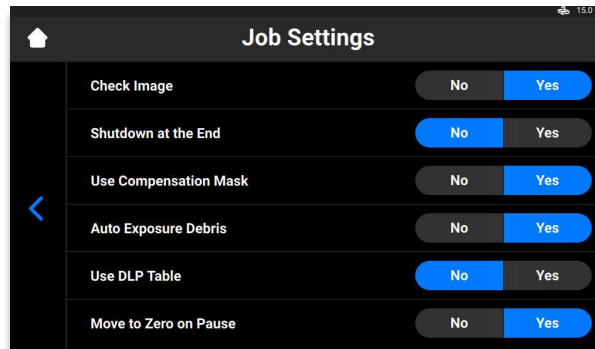

The following settings are available:

- **Check Image:** image verification.
 - Yes - all layers of the job are checked before starting the job.
 - No - the layers are not checked before starting the job.
- **Shutdown at the End:** shutdown the printer when the job is complete.
 - Yes - the printer turns off automatically after completion of the job.
 - No - the printer does not turn off after completion of the job.
- **Use Compensation Mask:** mask application.
 - Yes - the mask is applied to the projected image.
 - No - the mask is not applied to the projected image.
- **Auto Exposure Debris:** automatic exposure of the material tray to make cleaning the material tray easier.
 - Yes - the material tray is automatically exposed after the job has failed.
 - No - the material tray is not exposed automatically when the job has failed. In this case, you can manually perform the material tray exposure after the completion of the build process.
- **Use DLP Table:** DLP table application.
 - Yes - the DLP table is used.
 - No - the DLP table is not used.
- **Move to Zero on Pause:** build platform movement when the job is paused.
 - Yes - the build platform moves to Zero position.
 - No - the build platform stays at the current layer of the job.

Support

This tab lets you download the log report from the printer, provide remote access to the printer, and open a support case right from the printer. For more detailed information, see [Service and Maintenance](#).

Manual Debris Removal

This tab helps simplify the process of cleaning the material tray.

1. Select **Settings > Manual Debris Removal** to open the tab.

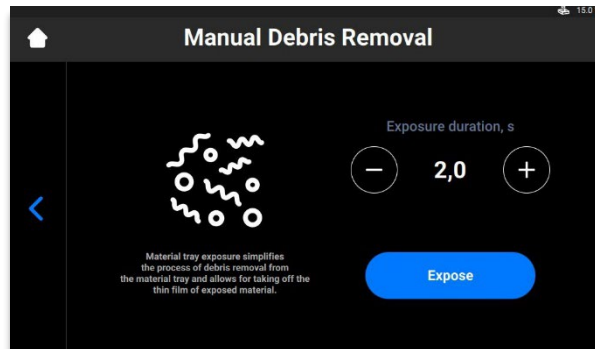

2. Set the required exposure time using the + and – icons.
3. Select **Expose**.
→ The entire material tray area is exposed.
4. Remove debris from the material tray by lifting the thin film of exposed material.
5. Proceed following the step-by-step for [Filter Material](#), if needed.
→ The following message appears.

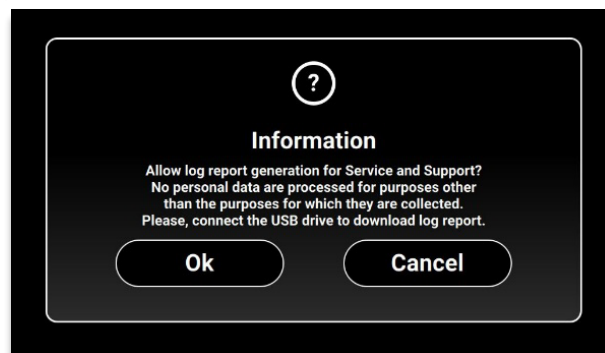

6. Make sure the USB-drive is connected to the printer and select **Ok**.
→ The report downloads to the USB-drive.

Job List Menu

1. Select **Job List** on the main screen of the Control Software to open the tab.

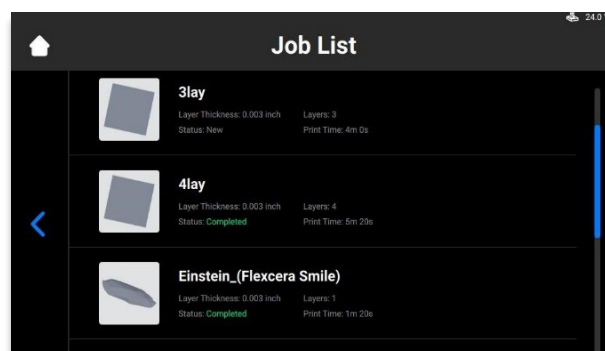

Einstein Pro XL Operations and Maintenance Guide

2. Scroll through the list to view different jobs and check information on job statistics:
 - **Layer thickness** – the thickness of one layer in μm .
 - **Layers** – the number of layers for the job.
 - **Print time** – the estimated time when the job will finish. This calculation is approximate and is updated dynamically after each exposure.
 - **Status** – the state of the job at a current time. It can be:
 - **New** – if the job has not been printed yet.
 - **Complete** – if the job has been printed successfully.
 - **Failed** – if the job has corrupted or failed due to material mismatch.
 - **Aborted** – if the job has been aborted manually or cancelled due to mechanical issues (projector/board does not respond, etc.)
 - **Invalid** – if a problem is detected when transferring the job file from Envision One RP® to Einstein Pro XL Control Software

Service Mode

The **Service Mode** tab can be accessed by **technicians and distributors only**.

Envision One RP®

All files to be printed must pass through Envision One RP model processing software before transferring to the Einstein Pro XL printer. Once the models are loaded, automatically fixed, oriented, and supported in Envision One RP, they may be transferred to the printer as a folder containing a series of images and files. This information is used by the printer to build three-dimensional models.

A USB drive containing the following program and data is included with each printer:

- Envision One RP® Software
- Buildstyles for the printer (.bsx)

For instructions on installing and operating, see [Envision One RP® User Guide](#).

Calibration

The printer is calibrated and tested during fabrication. However, calibration may be needed to guarantee accurate build results.

Home Position Calibration

Home position is the lowest point of the build platform along Z-axis, it is the start position of the build platform for printing.



Note: The home position calibration can be performed only when the parallelism is achieved.

Check Parallelism and Calibration

NOTICE

Always remove the platform before taking the material tray out of the printer.

Failure to do so can result in material dripping down into or onto the printer causing failed builds and damaged equipment.

Equipment:

- Digital calipers
- Scraper
- Material
- RFID material tag
- 3 mm Allen wrench
- Post-processing materials
- Home Position Calibration Cubes.stl file

Process the calibration .stl file:

To check, modify, or fine-tune the printer's parallelism and home position, the **Home Position Calibration Cubes.stl** file is printed. The printer must be powered on for the duration of the parallelism calibration, and the home position calibration.



Note: Parallelism is achieved when the platform and material tray are aligned with each other. Home position is the lowest point of the build platform along Z-axis, it is the start position of the build platform for printing.

1. Download the **Home Position Calibration Cubes.stl** file to the computer where the Envision One RP software is installed.



Note: Home Position Calibration Cubes.stl is a file made of nine blocks, each block is five millimeters high. This file is located on the USB-drive that is shipped with every printer, and in the Desktop Health [Knowledge Base](#).

Einstein Pro XL Operations and Maintenance Guide

2. Open the Envision One RP software and select a buildstyle. See the [Envision One RP® User Guide](#).
3. Import the .stl file into the Envision One RP software.
4. Print the **Home Position Calibration Cubes.stl** file, see [Start Job](#) for details.
5. Once the print has completed, check if there are nine cubes on the platform.
6. If any of the calibration cubes are missing, press the  icon and remove any cured particles that settled to the bottom of the material tray. Remove the cured material and discard.

Post-process:

7. Gently remove the calibration cubes from the build platform using the scraper from the Starter Kit.
8. Clean the calibration cubes.
9. Place the calibration cubes on a clean paper towel lined surface. Air dry in ambient room temperature/humidity for 10 min.
10. Take a close look at each printed calibration cube. The calibration cubes are labeled with numbers 1 through 9.



Figure 15. Calipers measuring calibration Cube 3.

Measure the calibration cubes:

11. Each calibration cube corresponds to a specific area of the material tray:

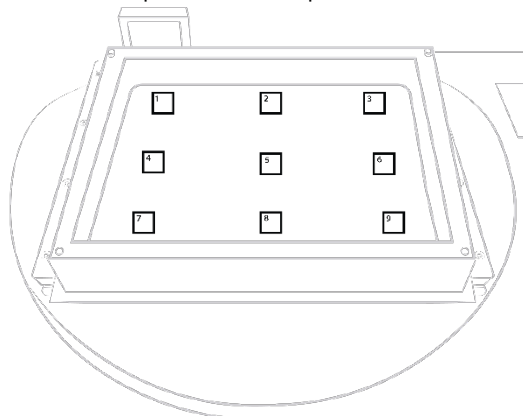

Figure 16. Material tray front view, calibration cube locations.

Einstein Pro XL Operations and Maintenance Guide

Measure the **height** of each calibration cube and write down the location of the calibration cube and its measurement.

- a) If all the calibration cubes are within +/- 100 microns, then the printer is paralleled, and no further actions need to be taken at this time.
 - b) If all the calibration cubes are within 4.85 and 5.0 mm, then the printer's home position is correct, and no further actions need to be taken.
12. If the home position is correct and the printer is not paralleled, contact [Customer Support](#).

If the printer is paralleled and the home position is not correct, skip to [Manual Home Position Calibration](#).

Manual Home Position Calibration



Note: The home position calibration can be performed only when the parallelism is achieved.

1. Remove the build platform from the printer and place it aside on a clean work surface, see [Remove Build Platform from Printer](#).
2. On the home screen, select **Settings > Move & Calibration > Home Calibration > Manual Homing**.
→ The following screen appears.

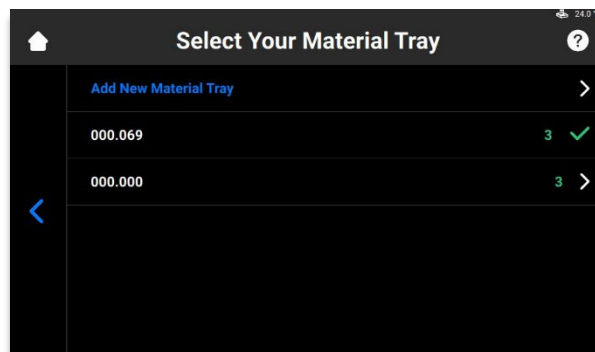

3. Select the material tray from the list.
→ The following screen appears.

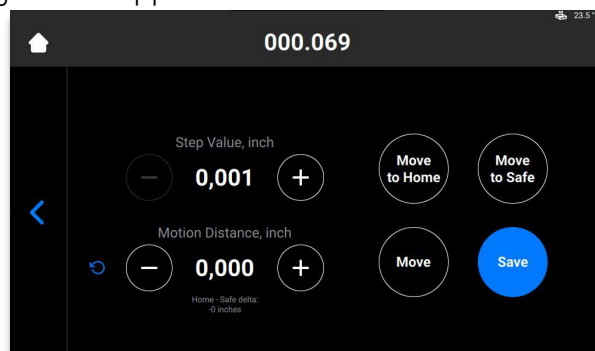

4. Select **Move to Home**.
→ The build platform holder moves down the Z-axis to the current home position.

Einstein Pro XL Operations and Maintenance Guide

5. Set the value of a step by pressing the - and + icons of **Step Value**. This is the increment used for the **Motion Distance**. The Step Value increments can be set to 0.01, 0.10, 1.00, and 10.00.
6. Set a motion distance of the platform by pressing the - and + icons of **Motion Distance**. This is the total distance the platform moves.

 **Note:** The positive values move the platform up; the negative values move the platform down. Pressing the refresh icon resets the motion distance value to zero.

7. Reference the values in **Step 11** of [Check Parallelism and Calibration](#) to determine the new home position. The adjustment should be made based on the average height of the calibration blocks.
 - a) If the average height measurement is below 4.90 mm, move the platform up by selecting **Move** the required number of steps.
 - b) If the average height measurement is above 5.10 mm, move the platform down by selecting **Move** the required number of steps.
8. Set the motion distance to the required adjustment. Select **Move** to make the adjustment and then select **Save**.
 - The build platform holder starts moving up to the top of the Z-axis.
 - The new home position is set.

Calibration of New Material Tray

1. On the home screen, select **Settings > Move & Calibration > Home Calibration > Manual Homing**.
 - The following screen appears.

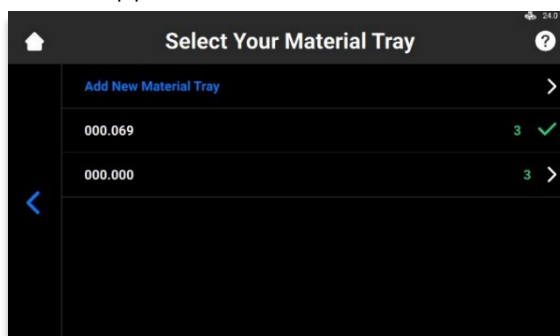

2. Select **Add New Material Tray**.
 - The following screen appears.

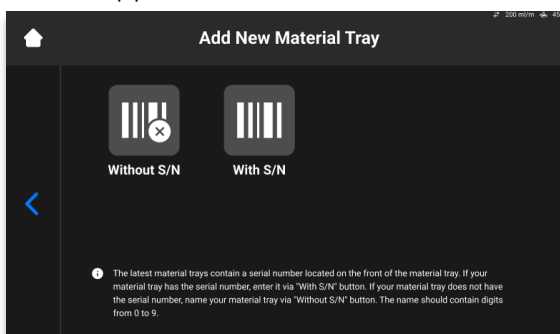

Einstein Pro XL Operations and Maintenance Guide

3. If your material tray has the serial number:
 - a) Select **With S/N**.
 - b) Find the serial number on the front of your material tray and enter it into the field on the screen that appears.

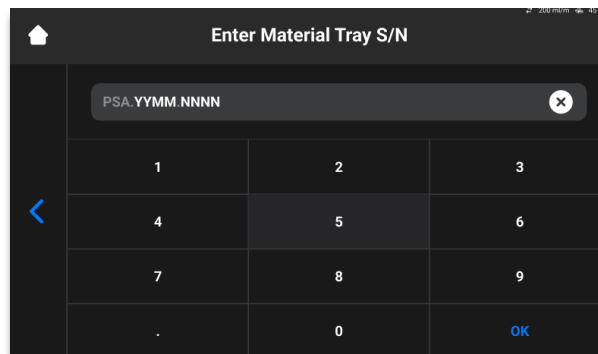

- c) Select **OK**.
→ The material tray is added to the list.
 - d) Move to step 3 of section [Manual Home Position Calibration](#) above to complete the calibration.
4. If your material tray does not have a serial number:
 - a) Select **Without S/N**.
 - b) Name your material tray and enter the name to the field on the screen that appears. The name should contain 8 digits from 0 to 9.

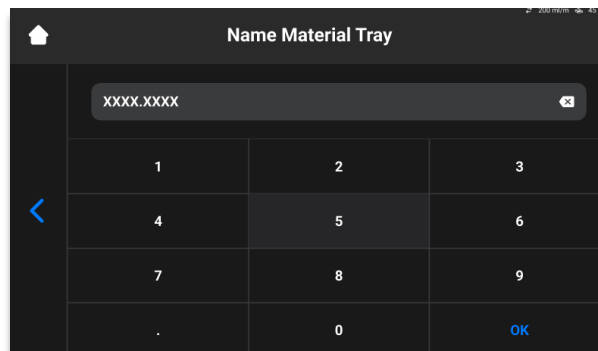

- c) Select **OK**.
→ The material tray is added to the list.
 - d) Move to step 3 of section [Manual Home Position Calibration](#) above to complete the calibration.

Mask Generation

Compensation mask is used to correct the possible unevenness of the projector power across the build envelope.

Required equipment:

- USB light sensor
- Safety glasses

Einstein Pro XL Operations and Maintenance Guide

To generate the compensation mask:

1. Insert the empty and clean material tray to the material tray holder.
2. On the main screen of the Einstein Pro XL Control Software, select **Settings > Move & Calibration > Mask Generation**.
→ The following message appears.

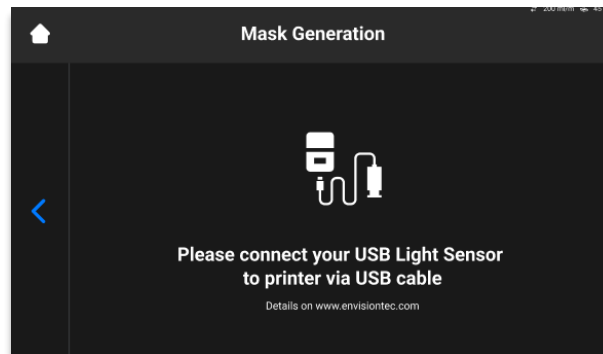

3. Connect your USB Light Sensor to the printer via USB cable.
→ The following screen appears.

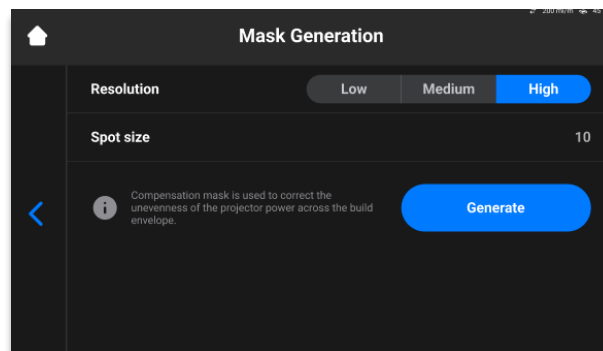

4. Select a resolution (Low, Medium, or High) in the **Resolution** field.



Note: Resolution defines the number of measurements that need to be done. The higher the resolution, the more measurements are needed.



Note: The spot size is set automatically based on the printer type and build envelope size.

5. Select **Generate**.

→ The following screen appears.

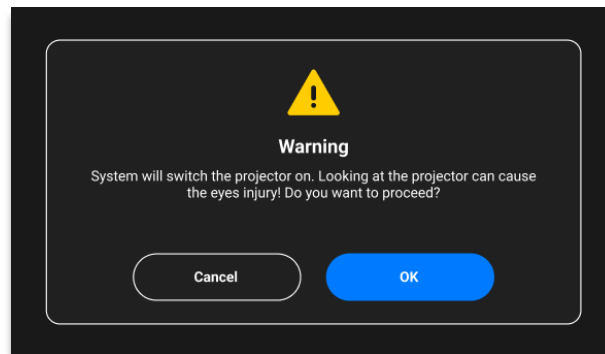

6. Make sure you have the UV protection glasses on and select OK to proceed.

→ The following screen appears.

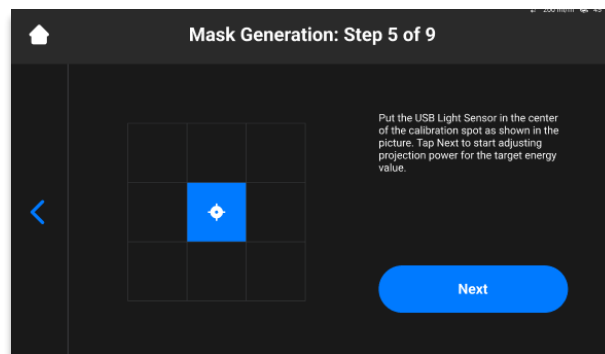

Note: Each box on the screen shown above corresponds to a spot of light that is projected onto the empty material tray. Select the required box to measure and adjust, if needed, its projection power or select **Next** to move to the next box.

7. Place the USB light sensor in the center of the light spot that is projected and select **Next** to start adjustment of projection power.

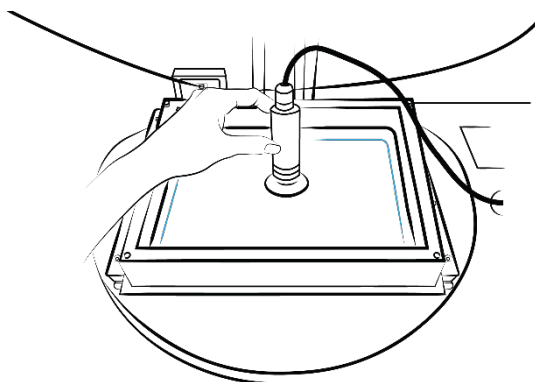

Figure 17: USB light sensor placement

→ The Next button becomes Pause button.

→ The projection power is being adjusted.

8. Repeat step 7 for each of the remaining boxes.

Einstein Pro XL Operations and Maintenance Guide

→ The confirmation screen appears.

9. Select **Apply** on the confirmation screen to save the newly generated mask and proceed working with the printer.
 - The newly generated mask has been saved.

Use Grey Mask

Set in the factory, the Grey Mask is the Compensation Mask for the Einstein Pro XL printer. To enable the Grey Mask on your printer, proceed as follows:

1. Select **Settings > Job Settings** on the screen of the Control Software.
2. Make sure the **Yes** option is selected in the **Use Compensation Mask** field.

Quick Calibration

The printer calibration allows you to set up compensation coefficients to tune the accuracy of your printer.

1. Print the L-shaped job.
2. After the L-shaped job is printed, clean it well and post-cure the model as required for the material in use.
3. Measure the printed model as shown below using a caliper.

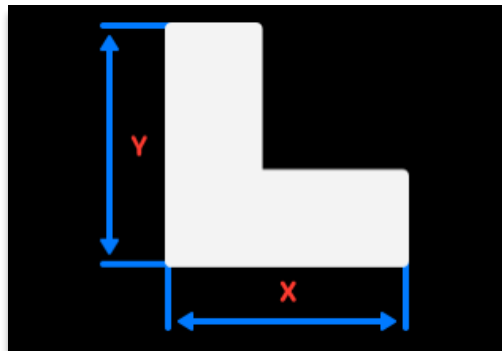

4. Select **Settings > Move and Calibration > Quick Calibration**.

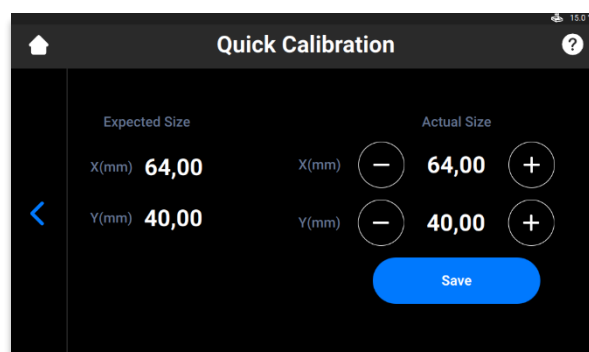

5. Enter the obtained X and Y values to the appropriate fields.
6. Select **Save** to confirm.

Start Print



CAUTION

Risk of injury from crushing caused by moving printer parts: Printer may only be operated by instructed and specially trained personnel. The printer may only be operated if the protecting devices are working properly.



CAUTION

Risk of injury: Do not use materials other than the materials branded or manufactured or qualified for use by Desktop Health®. Observe the relevant Material Safety Data Sheets for the materials. Use the appropriate personal protective equipment.

Check Z-axis

Ensure the printer has its Z-axis slide activated:

1. Select **Settings > Move & Calibration > Move** on the main screen.
2. Select the **up** and **down arrow** icons and make sure the building platform moves along the Z-axis. If the build platform does not move up, the reason could be that it has already reached its highest point.



Create Print Job in Envision One RP

To create the job in Envision One RP:

1. Open Envision One RP Software.
2. Select the printer, material, and layer thickness.
3. Add a model.
4. Orient a model and add supports as needed or use the **Hyper Print** feature.
5. Save the build job to a USB or transfer directly to the printer.

Load Job File

To load a job to the printer:

1. Enter Run into the Windows search field or use <Windows> + <R> hotkey on your computer keyboard.
→ The Run window opens.

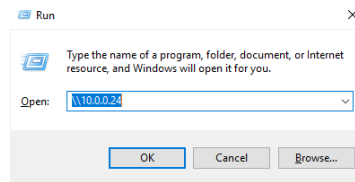

2. Enter the IP address of the printer, e. g.: \\10.0.0.24.
→ The Windows file explorer opens, showing the folders on the printer.

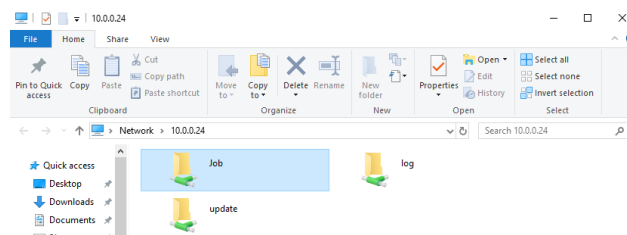

3. Open the Job folder.
4. Put the job files to the folder.
→ All the files from Job folder are now shown in the Job List tab.

Map a Network Drive in Windows

Map a network drive to access the Jobs folder from File Explorer in Windows without having to search for it or type its network address each time.

Windows 10

1. Open File Explorer from the taskbar or the **Start** menu, or select the **Windows logo key + E**.
2. Select **This PC** from the left pane.
3. On the **Computer** tab, select **Map network drive**.

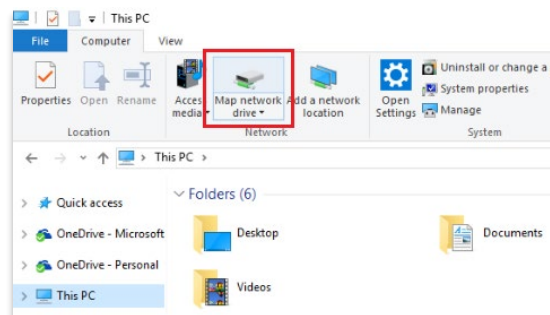

Einstein Pro XL Operations and Maintenance Guide

→ The following screen appears.

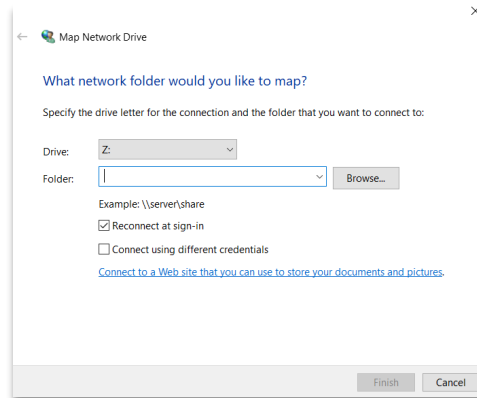

4. In the **Drive** drop-down list, select a drive letter (you can select any available letter).
5. In the **Folder** field, type the path of the folder or computer, or select **Browse** to find the folder or computer. To connect each time you sign in to your PC, check the **Reconnect at sign-in** checkbox.
6. Select **Finish**.

Windows 11

1. Open File Explorer from the taskbar or the **Start** menu, or select the **Windows** logo key + **E**.
2. Select **This PC** from the left pane.
3. On the File Explorer ribbon, select **More > Map network drive**.

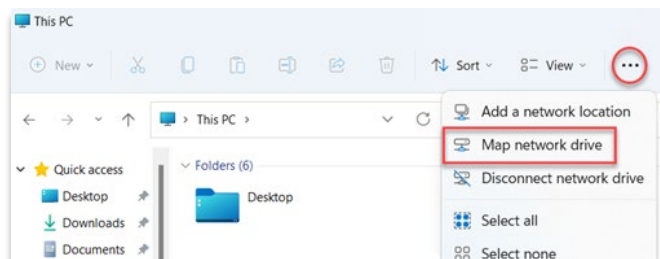

→ The following screen appears.

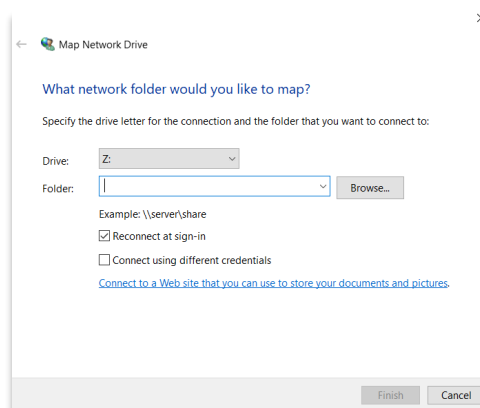

Einstein Pro XL Operations and Maintenance Guide

4. In the **Drive** drop-down list, select a drive letter (you can select any available letter).
5. In the **Folder** field, type the path of the folder or computer, or select **Browse** to find the folder or computer. To connect each time you sign in to your PC, check the **Reconnect at sign-in** checkbox.
6. Select **Finish**.

Create Shortcut

To create a shortcut to a network place in Windows allowing you to access FTP and Windows file shares, proceed as follows:

1. Open the Start menu, then search and select **This PC**.
2. Right-click on any empty space and select **Add Network Location**.

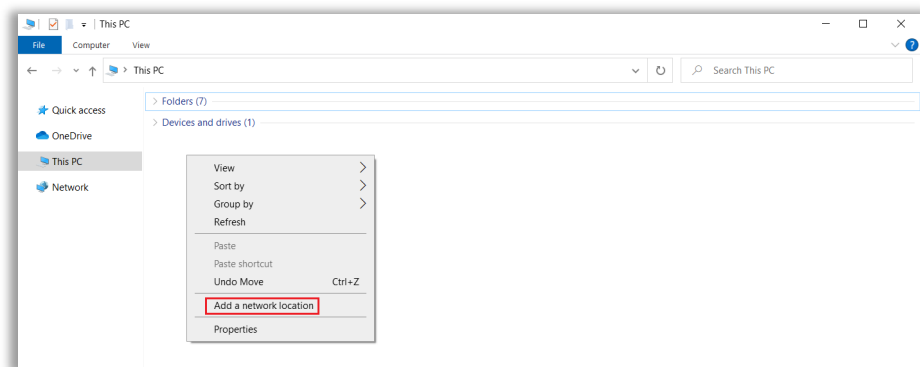

3. Select **Next** on the **Add Network Location Wizard** that opens.
4. Select **Choose a custom network location** and select **Next**.

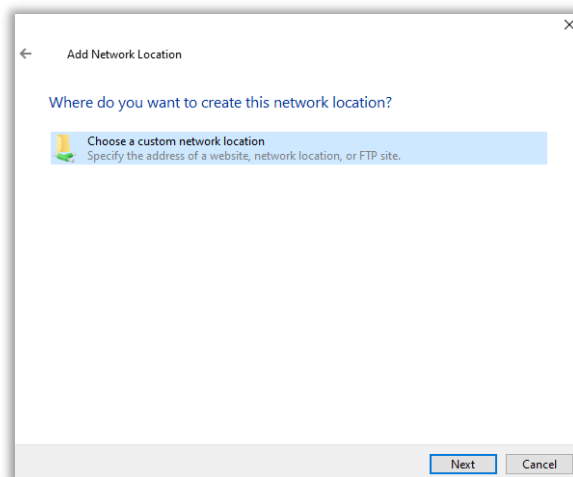

Einstein Pro XL Operations and Maintenance Guide

5. Type in the address, FTP site, or network location, then select **Next**.

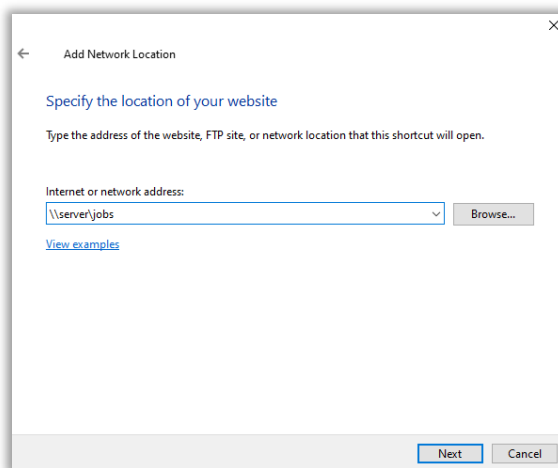

6. In the screen that appears, type a name for the network and select **Next**.
7. Select **Finish** on the **Add Network Location Wizard** screen.
 - The location is now listed under **Network Locations** tab in **This PC**.

Load Job via FTP

To load a job to the printer:

1. Enter the IP address of the printer, e. g.: ftp://10.0.0.114.
 - The Windows file explorer opens, showing the folders on the printer.

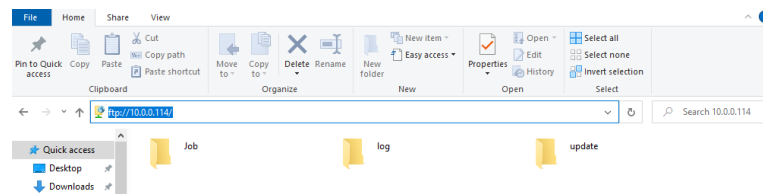

2. Open the **Job** folder.
3. Put the job files to the folder.
 - All the files from Job folder are now shown in the **Job List** tab.

Load Job from USB Drive

To save a Job to a USB drive:

1. Connect the USB-drive to the PC with the installed **Envision One RP**.
2. Open the **Envision One RP**.
3. Create the job you want to save.
4. Select the job you want to save.
5. Select **Print**.

Einstein Pro XL Operations and Maintenance Guide

→ The following window appears.

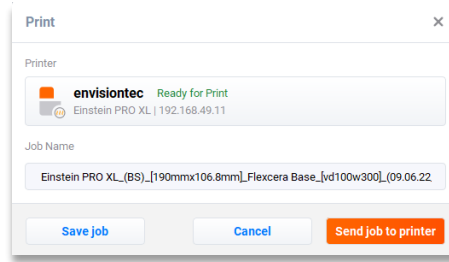

6. Select **Save job**.

→ The folder selection dialog box appears.

7. Open the USB-drive folder you want to save a job to and select **Select Folder**.

→ The job folder with all the required data is saved to the selected USB-drive.

→ The following window appears.

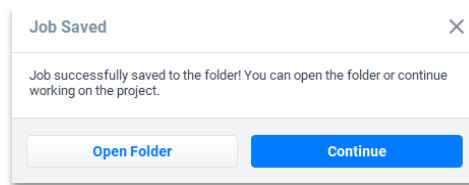

8. Select either:

→ **Continue** to exit the Save job dialog box; or

→ **Open Folder** to open the Job folder.



To load a job directly from the USB-drive:

1. Upload the required job to the USB-drive as described above.

2. Insert the USB-drive with the uploaded job into the corresponding plug of the printer.

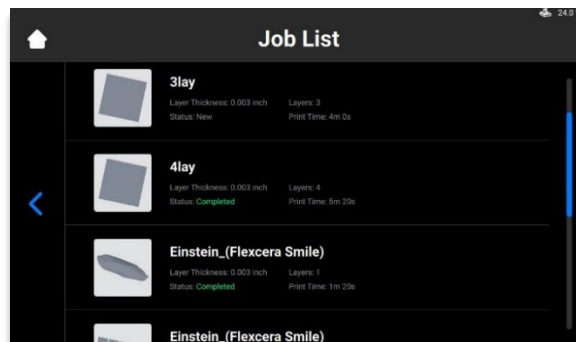
→ The job is automatically added to the **Job List** on the home screen.



Note: The  icon indicates USB drive is connected to the printer. The  icon in the Job list indicates the job was added via USB drive.

Load Job from Envision One RP

1. Open the Envision One RP.
Requirements: At least one opened and selected 3D model.
2. Select the Print button in the Print Menu.
 → The following window appears:

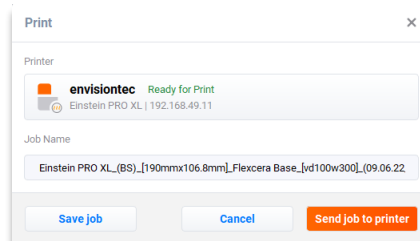

3. Select the Printer field.
 → The following window appears:

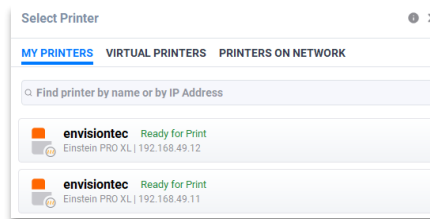

4. Select a printer to send your job to and click on it.
 → The job is sent to the selected printer.



Note: Printers in the network can have the following statuses: Ready for Print, Printing, Offline. You cannot send a job file to a printer with the Offline status.

Verify Einstein Pro XL Is Ready to Print

NOTICE

Checking the printer ensures the highest quality of printed models and minimizes the risk of errors or printer malfunctioning.

Before beginning a print, always check the following things:

- The hood is closed.
- The flat surface of the build platform is clean and free of all cured material, and the build platform torque knob is secured in position.
- The material tray is secured in position.
- The material tray is filled to the fill line, and all material handling instructions are followed for the specific material used (mixing, temperature, etc.)

Einstein Pro XL Operations and Maintenance Guide

- The material tag is on the material tag reader, and the tag matches the material in the tray and in the buildstyle.

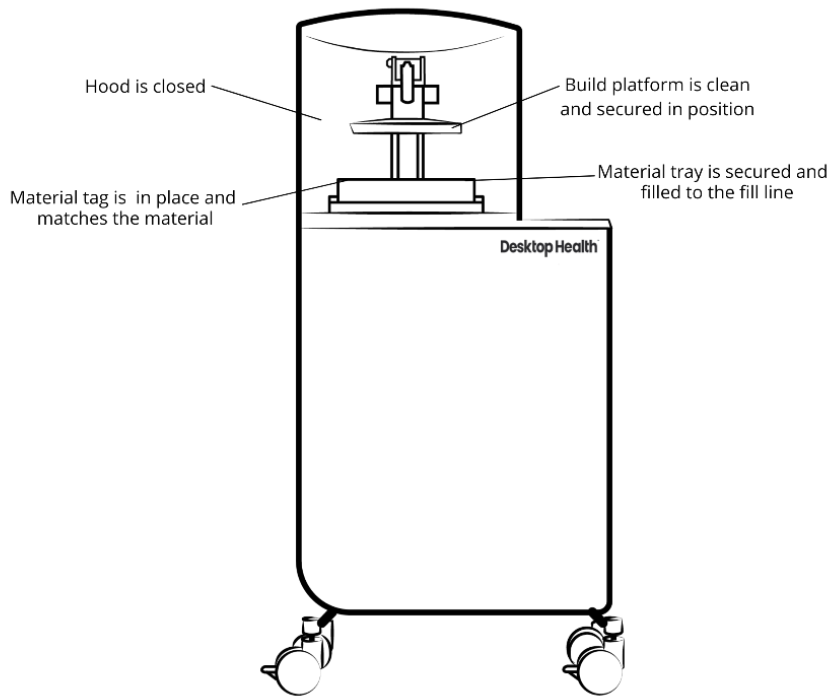

Figure 18: The Einstein Pro XL Printer

Start Print

NOTICE

Make sure the build platform is clean and the material tray is in place and has material in it before starting a print.

Failure to do so will result in failed builds and damage to the equipment.



Note: Before starting a print, the software checks the buildstyle in the job matches the material tag on the printer. If they do not match, then the job will not start.



Note: To pause a job, use the Pause Job button. All other methods will likely result in a failed build. Proceed with attention.

Einstein Pro XL Operations and Maintenance Guide

To start a job:

1. From the Home screen, select Job List:

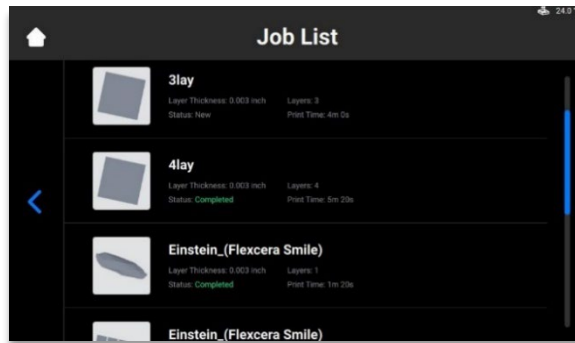

2. Select the job folder from the Job List.

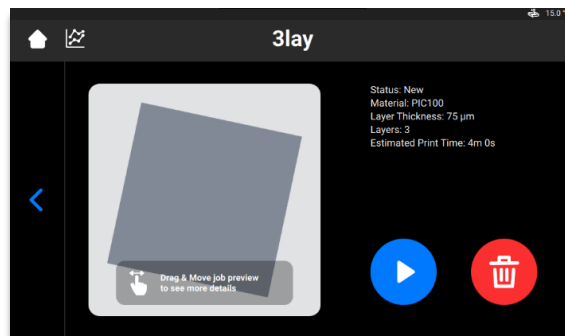

3. Select the Play button to start a job.
→ The system checks if the printer is ready to start a print.

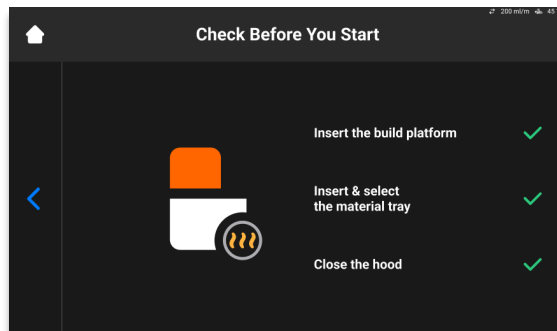

→ The following window appears.

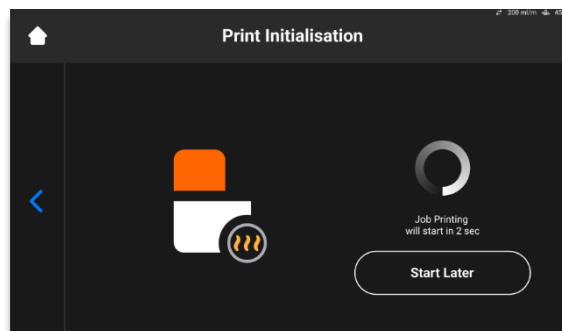

4. To start the job now, wait until the job starts.

Einstein Pro XL Operations and Maintenance Guide

To delay your job print, select **Start Later**.



Note: The minimum delay time is 15 minutes. The maximum delay time is 999 h 45 min.

→ The following window appears.

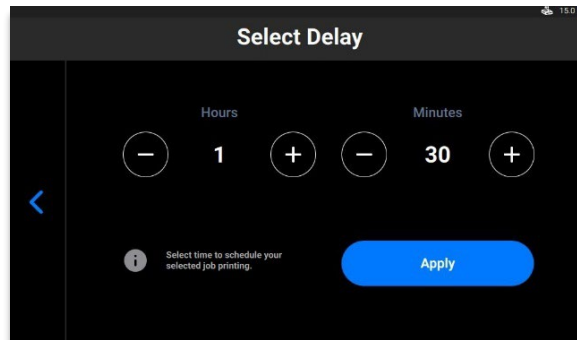

5. Set the required delay time using the plus and minus icons in the **Hours** and **Minutes** fields and select **Apply**.

→ The print initialization window appears.

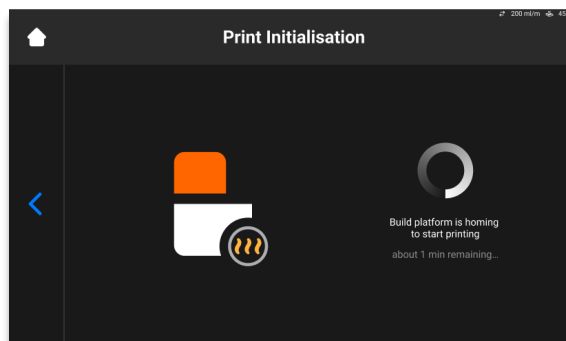

6. Wait until the job starts.
 - The build platform homes.
 - The job starts.

Stop Job

To stop or abort the print, the following options are available:

- Abort Job
- Delete Job

Abort Job

The job can be aborted by selecting the **X** icon in the job printing window.

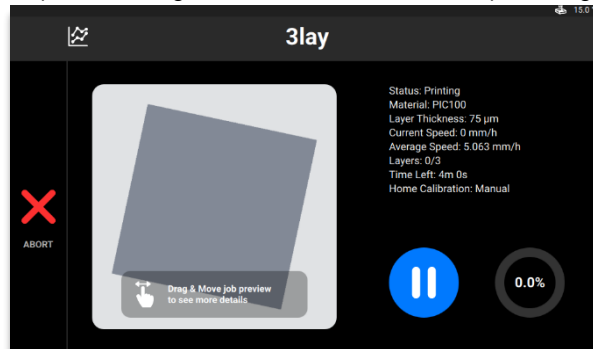

→ The following window appears.

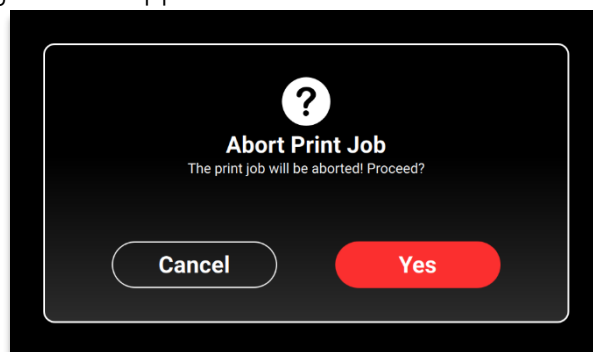

1. In the confirmation window, select **Yes**.
 - The job has been aborted.
 - The following window appears.

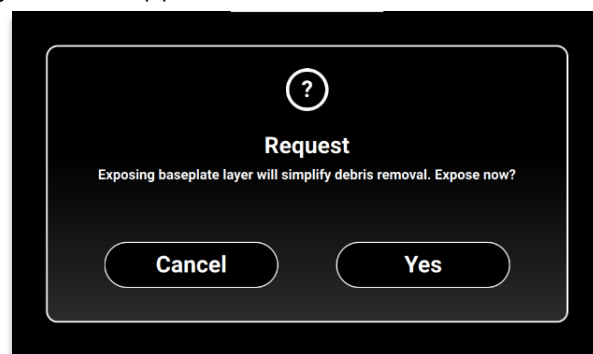

- If there is no need to simplify the process of cleaning the material tray, select **Cancel**.
 - To simplify the process of debris removal from the material tray, select **Yes**.
 - The job has stopped.
 - The whole material tray area has been exposed.
2. Remove debris from the material tray by simply taking off the thin film of exposed material and following the procedure for [Filter Material](#).

Delete Job

To delete the job from the Job list:

1. Select **Job List** on the main screen.

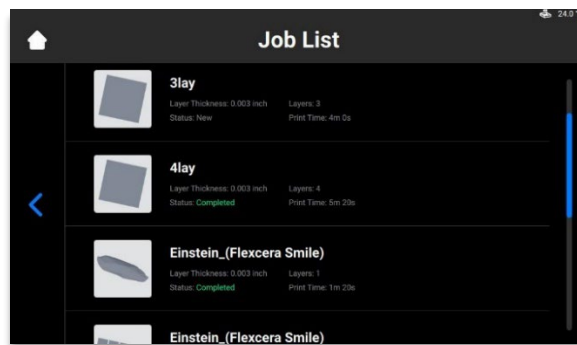

2. Select the job you want to delete from the list of jobs.
→ The following screen appears.

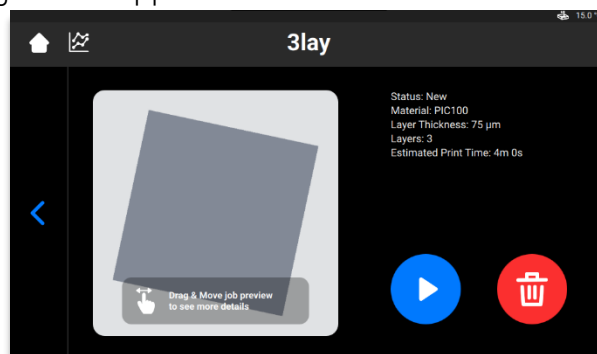

3. Select the **Waste Bin** icon to delete a job file.
→ The following confirmation window appears.

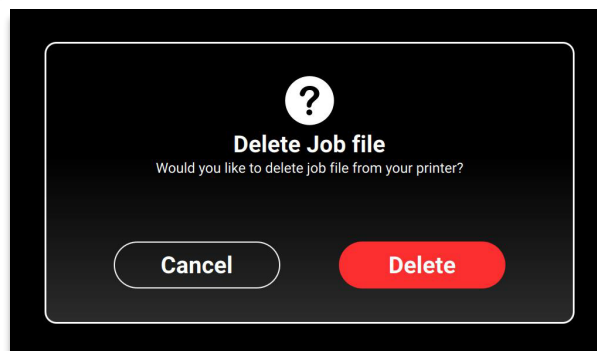

4. Select **Delete** to confirm job file removal.

Post-Process

Post-Cleaning Supplies and Post-Curing Equipment

Recommended list of cleaning supplies:

- Spray bottle (optional).
- Plastic containers with lid for holding the isopropyl alcohol.
- Isopropyl alcohol (99%) for cleaning uncured material on the surface of printed models.
- Soft artist or make-up brush.
- Precision knife/surgical blade or small nail snips for removing supports from models.
- Compressed air for removing isopropyl alcohol and uncured material from the surface of printed model.
- Paper towels.
- Post curing unit.

Remove Build Platform from Printer

When a print job is successfully completed, the build platform rises to the top of the Z-axis tower. The build platform with the printed models is ready to remove. Have a paper towel ready to catch potential drops of uncured material.

To remove the build platform with printed models:

1. Open the printer's hood.
2. Place one hand on the build platform handle. Loosen the build platform torque knob with the other hand.
3. Lightly cradle the bottom of the build platform with the paper towel. This will help to prevent dripping while removing the build platform from the printer.

Detach Models from Build Platform



CAUTION

Risk of injury: As handling chemicals puts you at risk of coming into contact with corrosive chemicals, being burnt, inhaling poisonous vapors, etc., always put on suitable protective clothing (gloves, protective goggles, etc.) before working with construction substances. Take utmost care to avoid getting any chemicals in your eyes or breathing the chemical vapors in. Always wash your hands thoroughly afterwards with soap and water only. Don't use Isopropyl alcohol to wash your hands if you come in contact with materials. Take care not to spill any chemicals.

Einstein Pro XL Operations and Maintenance Guide

Once the job is complete, the printed models hang off the build platform.

To remove the models, proceed as follows:

1. Place the build platform on its side in the processing zone as shown in the diagram below. Watch the material so it doesn't leak into the build platform cavity. Ensure the magnet stays clean.
2. Hold the build platform handle with one hand to steady the platform.
3. Use the scraper from the Starter Kit to gently detach models from the build platform. Angle your tool roughly 30 degrees from the platform and move the blade while applying a light amount of pressure.

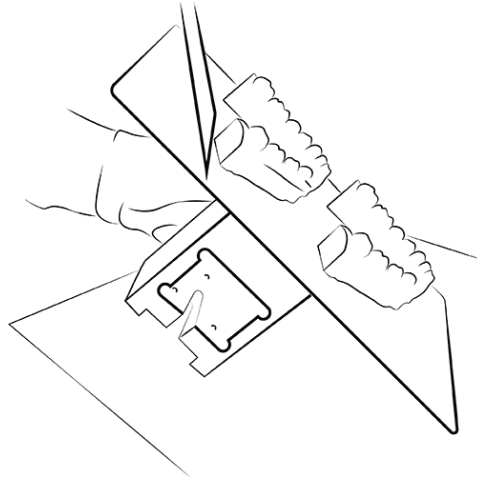

Figure 19: Separation of a model from the build platform

4. Place each model on a paper towel to catch the excess material as it drips.



Note: The models appear to be glossy. This is because uncured material is covering the surface.



Note: If the model doesn't begin to separate easily, move to a different area, working your way around the model until it safely dislodges from the build platform.

Reset Printer After Printing

1. Once the models have been removed, use the scraper to remove any remnants of the cured material from the surface of the build platform.
2. Wipe the entire platform dry using a paper towel. The previous print job shouldn't be visible on the platform.
3. Install the build platform on the printer and tighten the build platform torque knob.
4. Close the hood.
→ The Einstein Pro XL can now begin printing the next loaded print job.

Clean Printed Models

The PWA 2000 Parts Washing Apparatus is the recommended washing unit for the models printed with non-medical materials using the Einstein Pro XL printer. To get the information on how to clean a printed model with PWA 2000, see [Hardware Operations PWA 2000](#).

Contact your distributor for further details on parts washing units for the Einstein Pro XL printer.

Post-Cure Printed Models

The Otoflash is the recommended curing unit for all materials printed with the Einstein Pro XL. To cure models using the Otoflash parts curing unit, see [Hardware Operations Otoflash](#).

The PCA 2000 Post Curing Apparatus is also available for non-medical materials printed with Einstein Pro XL. To cure the models using the PCA 2000, see [Hardware Operations PCA 2000](#).

Finish Post-Processing of Printed Model

Finishing is the final step in post processing a printed model. With finishing, grind all traces of supports and polish models as needed, depending on the final part application.

1. Grind support bumps using a fine burr and rotary tool, or manually using sandpaper.
2. Remove dust particles by quickly spraying the model(s) with 99% IPA in a spray bottle, and dry immediately with compressed air.

Service and Maintenance



CAUTION

Risk of injury: crushing caused by automatically moving printer parts. Body parts may be crushed by movements of the build platform. The printer may only be operated if the protecting devices are working properly.



CAUTION

Risk of injury from slipping, stumbling or falling of persons through loose cables, objects or liquids on the floor. Keep the printer area clean and dry. Make sure that no loose cables or objects are lying on the floor of the printer area. Place all printer cables carefully to prevent trip hazard. After repairing the printer, place cables back carefully to prevent trip hazard. Remove tools and other objects from the printer. Inform the personnel of residual risks.



CAUTION

Risk of injury caused by the ergonomics of the printer. Maintain a healthy posture. Instruct the personnel accordingly.

The following sections contain information on service and maintenance of the printer. Regular maintenance according to the maintenance plan is an essential precondition for efficient use of the printer.

- Section [Customer Service](#) describes the ways to get the technical support in case you face any issues with the printer.
- Section [Operational Maintenance](#) describes the operational maintenance and how to carry out the maintenance tasks.

Customer Service

EnvisionTEC GmbH
Brüsseler Str. 51
D-45968 Gladbeck
Germany
Phone: 49 2043 9875-0
E-Mail: support@desktophealth.com

Desktop Health
15162 S. Commerce Dr.,
Dearborn, MI 48120, USA
Phone: 866-344-3578
E-Mail: support@desktophealth.com

Download Log Report

The log report contains printer information and statistics which can be analyzed by Service and Support.

1. Connect the USB drive to the printer.
2. On the home screen of the printer, select **Settings > Support > Download Log Report** to open the tab.

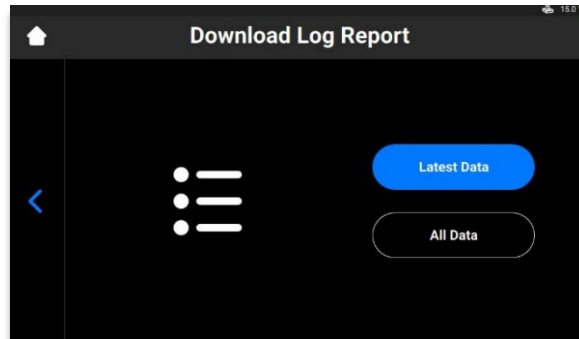

3. Select **Latest Data** to download the latest printer information; or **All Data** to download the report containing all information received during printer operation.

To send the log report to Service and Support, proceed as follows:

1. Open the USB-drive folder.
2. Find the file with the similar name: snapshot_2019-09-26T14-01.zip.
3. Send it to your personal Service and Support manager.

Remote Assist

This feature lets you provide remote access to the printer to the support representative.

1. On the home screen of the printer, select **Settings > Support > Remote Assist > Enable Remote Access**.

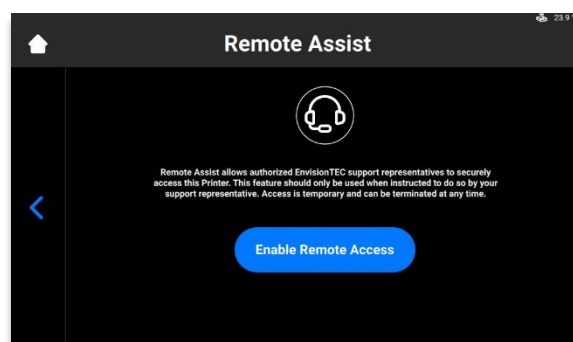

Einstein Pro XL Operations and Maintenance Guide

→ The following screen appears.

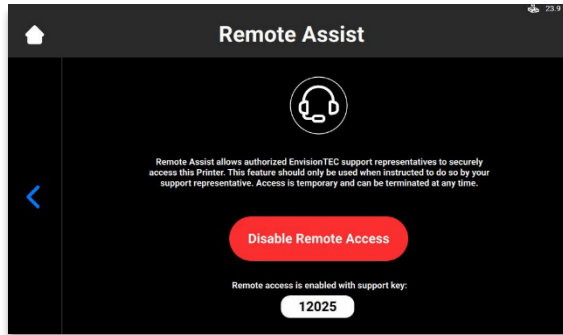

2. Provide the 5-digit support key to your support representative via email support@envisiontec.de with the subject "Remote Assist Code for Support".
→ The remote session starts.
3. To terminate the remote session, select **Disable Remote Access**.

Request Support

This feature lets you open the support case from the printer.

1. Select **Settings > Support > Request support**.

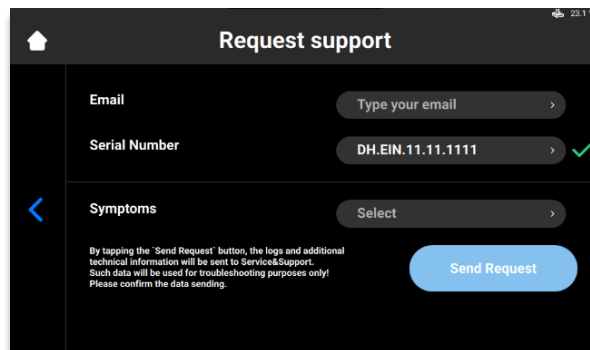

2. Type your e-mail in the **E-Mail** field.
3. Type the printer serial number in the **Serial Number** field.
4. Select **Symptoms**, select the issue(s) by checking the corresponding box.

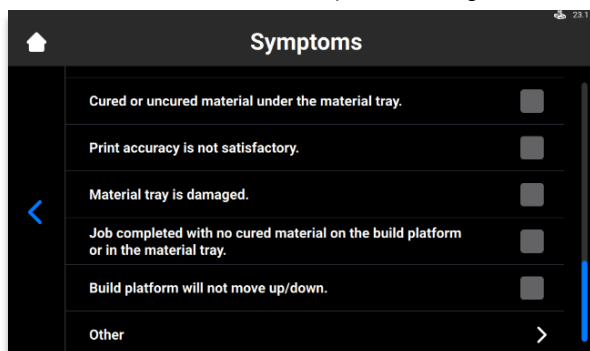

Einstein Pro XL Operations and Maintenance Guide

- If the issue is not in the list, select Other, type the issue using a keyboard, and confirm with OK.

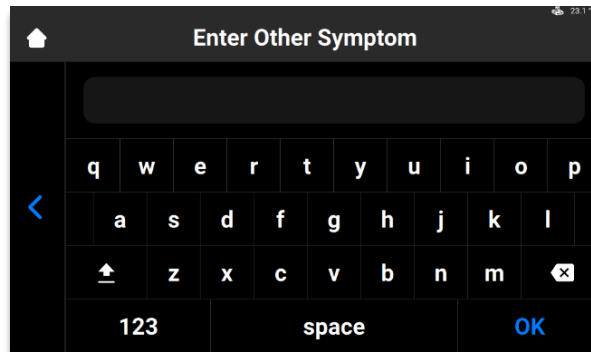

- Select the back button to save the changes and return to Request support menu. → Once all fields are filled, they are marked with green checkmarks.

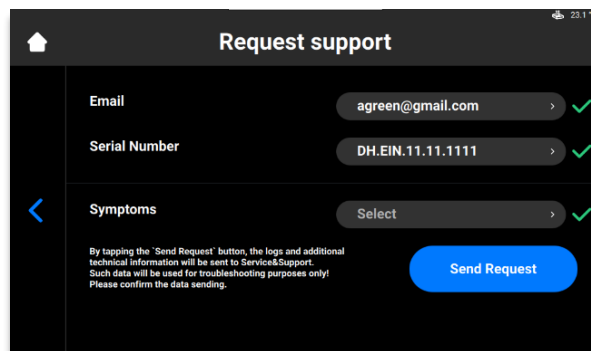

- Select Send Request. → Your request is submitted. The next available technician will assist you.

Operational Maintenance

NOTICE	Complete maintenance tasks according to the table below and the intervals specified therein.
---------------	--

 **Note:** Maintenance activities, including date and performing operator, should be documented due to traceability.

Einstein Pro XL Operations and Maintenance Guide

Operational maintenance helps ensure a smooth and efficient production process. The operating personnel can carry out these tasks after being trained accordingly.

Task	Maintenance Interval
Cleaning the build platform	Print-by-Print
Cleaning the printer casing	Print-by-Print
Cleaning the material tray	Weekly
Cleaning the hard drive space	Weekly
Cleaning the PWA 2000 or Washing Containers	Weekly
Cleaning dust	Weekly
Power Cycling	Weekly
Cleaning the projector lens	Bi-weekly
Cleaning the touchscreen	Monthly
Checking the safety equipment	Daily Every time the printer is put into operation Every time the printer has been repaired

Clean Build Platform

NOTICE	Use 99% IPA away from the material tray and thoroughly wipe all IPA completely from the build platform before installing it back onto the printer.
---------------	--

Time needed: Approximately two minutes

Maintenance frequency: Print-by-Print

The build platform should remain as clean as possible between print jobs to keep your printer in optimal printing condition. It is recommended to clean the build platform under any of the following conditions:

- The build platform is sticky.
- Material is cured around the build platform clamping handle.
- When changing the material type.

Step-by-step:

1. Clean the connection cavity at the top of the build platform using a cotton swab with 99% IPA.
2. If too much material has cured in the torque knob screw threading, replace the build platform.
3. Clean the surface of the build platform using a clean paper towel.
4. Check every surface for material, buildup, or stickiness.

5. Clean the excessive buildup using a small amount of 99% IPA on a clean paper towel or cotton swab.
6. Hard spots of cured material can be carefully scraped off using the paint scraper from the Starter Kit.

Clean Material Tray



Risk of injury: Always wear nitrile gloves when handling the items that come into contact with uncured resin.

NOTICE

Always remove the platform before taking the material tray out of the printer. Failure to do so can result in material dripping down into or onto the printer causing failed builds and damaged equipment.

NOTICE

Always clean the material tray each time you need to change the material for printing parts on the printer.

NOTICE

Do not pour material from your material tray into the bottle it came from! This can potentially contaminate the whole bottle of material and ruin it.

NOTICE

Never use chemicals inside the material tray. This will contaminate and ruin any material you put into the material tray.

Time needed: Approximately five minutes

Maintenance frequency: Weekly

Overview: The material tray is a consumable with an approximate lifespan of up to 90 prints. Order a new material tray before the current tray expires or becomes damaged.

The Pre-Stretched Assembly (PSA) is located inside the material chamber and is comprised of a film and a metal frame.

Step-by-step:

1. Check the film at the bottom of the material tray whenever the material is removed.
2. Look for pinholes, punctures, ripples, and other signs of stress. A slightly cloudy film is normal and will not affect the print quality.
3. Use Manual Debris Removal to remove cured material from the surface of the film assembly at the end of a print or access it using the following sequence – **Home > Settings > Manual Debris Removal**.
4. Once the exposure time is set on the **Manual Debris Removal** page, select **Expose** – the projector will expose the full printing area to light for the set

exposure duration. Use a material mixing card from the Starter Kit to gently remove the cured material from the surface of the film assembly.

Clean Printer Casing

Time needed: Approximately two minutes

Maintenance frequency: Print-by-Print

Overview: The printer's metal casing protects the internal components from damage. To avoid spilling material on the casing, always hold a paper towel under the build platform and the material tray while installing or removing. Spilled material cured to the casing can be difficult to remove.

Step-by-step:

1. Wipe the spilled material as soon as it touches the printer before it cures.
2. Remove most of the spill with a dry paper towel first, then lightly spray a second paper towel with IPA and wipe away any residue.



Note: If rubbed with too much pressure or for too long, the casing may become discolored.

Clean Projector Lens

Time needed: Approximately five minutes

Maintenance frequency: By-weekly

Overview: The Einstein Pro XL projector receives build job information from the internal computer, based on which it projects a clear image onto the material tray layer by layer. The projector lens must remain clean and free of dust/debris.

Step-by-step:

1. Power off the printer completely.
2. Open the printer door.
3. Locate the projector inside.
4. Gently wipe the projector lens with the microfiber cloth.
5. Close and lock the printer door.

Clean Hard Drive Space

Time needed: Approximately five minutes

Maintenance frequency: Weekly

Overview: The Einstein Pro XL has an internal PC that can store a limited amount of data. It is a good practice to remove print job folders from the printer to free up space. When most of the hard drive space has been used, the printer may show error messages or respond slowly to touchscreen commands.

Einstein Pro XL Operations and Maintenance Guide

Step-by-step:

1. Power the printer on.
2. On the Einstein Pro XL touchscreen, select **Home > Job List**.

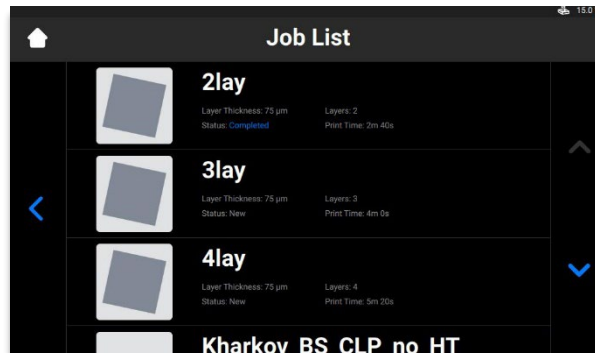

3. Select the print job folder name.
4. Select the **Waste Bin** icon.
→ The unwanted print job folder is now erased from the printer.
5. Repeat these steps until all unwanted print job folders have been removed.

Clean PWA 2000 / Washing Containers

Time needed: Approximately fifteen minutes

Maintenance frequency: Weekly

Overview: The PWA 2000 must be emptied when the bottom of the container is no longer visible. The 99% IPA will collect particles of uncured material over time.

Step-by-step:

Check your local protocol for safe handling of 99% IPA.

PWA-2000:

1. Remove the washing compartment from the PWA 2000.
2. Pour the IPA from the pour spout into an IPA recycling container.
3. Wipe down the interior of the washing compartment with a clean paper towel.

Washing containers:

1. Remove the used IPA from the dirtier bath.
2. Wipe the container clean using a paper towel.

Clean Dust

Time needed: Approximately five minutes

Maintenance frequency: Weekly

Overview: Dust may accumulate on, near, or inside of the Einstein Pro XL. High levels of dust accumulation can cause the printer to overheat.



Note: To protect the internal hardware, the printer automatically shuts down if it reaches the maximum internal temperature of 49 C/120 F.

Step-by-step:

1. Listen to the fan for inconsistency, stress, or obstructions when the printer is powered on.

Einstein Pro XL Operations and Maintenance Guide

2. To remove dust, power down the printer, disconnect the power cable and then wipe the vents and fan with a microfiber cloth.
3. After the printer has been cleaned, look down through the space under the material tray to make sure that there isn't any dust or debris on the lens.

Power Cycle

Time needed: Approximately five minutes

Maintenance frequency: Weekly

Overview: It is recommended to power cycle the printer under any of the following conditions:

- The printer is running slowly.
- The printer was recently updated.
- The printer has not been powered down in a week

Maintain Materials

Time needed: Approximately five minutes to mix material, depending on the material + 15 minutes to empty and clean the material tray.

Maintenance frequency: Print-by-Print

To maintain materials:

Protect material in the material tray from ambient light by keeping the hood closed.

Mix the material in the material tray before each print using a material mixing card from the Starter Kit. Step-by-step:

1. Lightly skim the mixing card back and forth across the surface of the material in the tray.
2. Mix carefully to avoid puncturing or tearing the film at the bottom of the material tray.
3. Mix the material until it's a completely uniform color.

Check the material for solids or debris. If found, filter the material. Step-by-step:

1. Remove the material tray from the printer.
2. Set the funnel and cone-shaped paint filter on top of a separate opaque storage bottle.
3. Pour the material out by tipping the front corner of the tray.
4. Use a material mixing card to assist in guiding the material into the filter.
5. When finished, dispose of the filter, and clean the funnel with a dry paper towel.



Note: For more specific information on handling a material, see the corresponding Material Safety Data Sheets.

Desktop Health™

Desktop Metal, Inc.

Desktop Metal Operating, Inc.

Desktop Health

63 3rd Ave.

Burlington, MA 01803

<https://www.desktopmetal.com/>

<https://health.desktopmetal.com/>

EnvisionTEC US LLC

15162 Commerce Dr. S

Dearborn, MI 48120

<https://etec.desktopmetal.com/>

EnvisionTEC GmbH

Brusseler Str. 51

45968 Gladbeck

Germany

ExOne Operating, LLC

127 Industry Boulevard

North Huntingdon, PA 15642

<https://www.exone.com/>

ExOne GmbH

Daimlerstrasse 22

86368 Gersthofen

Germany

ExOne KK

161-5 Haneo

Odawara-shi, Kanagawa

Japan 256-0804

Adaptive3D LLC

1122 Alma Road, Suite 100

Richardson, TX 75081

<https://adaptive3d.desktopmetal.com>